



# Assotherm

Servizi associati per la termoidraulica

**Catalogo 2017**

Riscaldamento e Valvolame - Heating and valves - Chauffage et Robinetteries

## ...: Presentazione Azienda

Assotherm srl è una realtà affermata nel settore della componentistica per impianti idrotermosanitari e di condizionamento, che grazie alla decennale esperienza maturata nel settore, garantisce l'approvvigionamento di prodotti derivanti dal ciclo di produzione di metalli come ottone, alluminio, acciaio, rame, ghisa e derivati.

Esempio della produzione sono: valvole a sfera, rubinetterie per riscaldamento, valvole di sicurezza, valvole di taratura, valvole di zona, collettori, filtri, accessori per centrale termica e raccorderie di ogni genere per le differenti tubazioni in commercio.

Un processo di costante monitoraggio della produzione, gestita secondo i parametri dei Certificati di Qualità del prodotto e la grande attenzione allo sviluppo tecnologico dei nuovi sistemi volti ad offrire sempre maggiori vantaggi all'installazione, ci collocano come interlocutori di primo piano nella offerta di queste tipologie di prodotto, nonché validi partner, sempre pronti a saper consigliare al meglio le aspettative della clientela, aumentandone le potenzialità.

Chi da anni lavora con noi, ci apprezza il tempismo con cui reagiamo alle richieste e soprattutto ci riconosce la garanzia di un prodotto di Qualità, ben garantito da un elevato rapporto Prezzo/Qualità.

Lieti pertanto di poter valutare tutte le proposte che ci giungono (con particolare attenzione a particolari su specifico disegno del cliente), ci auguriamo possiate essere parte dell'entusiasmo e della superba volontà che oggi è il segreto della nostra azienda.



## ...: Something about us

Assotherm SRL is an Italian established reality in the components industry for plumbing, heating and cooling; thanks to decades of experience, we ensure the supply of products resulting from the cycle of production of metals such as brass, steel, copper, iron and derivatives. We have a broad product line of standard control devices to meet demanding customer requirements. Our products (we export in over 30 Countries) provide another example of our customer-driven, problem solving capabilities and our values are hard work, innovation, safety, style.

Example of the production are: brass ball valves, valves for heating, safety valves, balancing valves, zone valves, manifolds, filters, accessories for central heat and couplings of all types for the various pipes on the market. A process of continuous monitoring of production, managed according to the parameters of the Certificates of Quality product and great attention to technological development of new systems for offering still more to install, place us as reputable partners leading in offering these types of product, as well as good partners, always willing to know how to best advise customer expectations, by increasing the potentialities.

Products are developed our Engineering and Technical Department, starting from the moulds through stamping, working, assembling up to the final product and, in order to offer our customers a greater variety of articles, we have a number of "sister companies", Made in Italy, which by the time we have established mutual cooperation.

Those who for years worked with us, appreciate the timing with which we respond to requests and especially recognizes the guarantee of product quality, well secured by a high ratio of price / quality. Experienced sales personnel and service engineers are ready to troubleshoot your needs.

Therefore pleased to be able to evaluate all proposals that come to us (focusing in particular on the specific design of the customer), we hope you will be proud of the enthusiasm and determination which today is the secret of our

## ...: La nostra presenza / Our presence

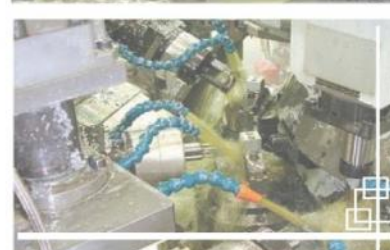

>> Valvole a sfera / Ball Valves / Robinets à boisseau spherique	<u>Pag</u> 4
>> Riduttori di pressione / Pressure reducing valves / Reducteurs de pression	<u>Pag</u> 13
>> Prodotti complementari acqua / Various water products / Produits divers pour l'eau	<u>Pag</u> 16
>> Strumenti di misurazione e intercettazione / Measuring components / Instruments de mesure	<u>Pag</u> 23
>> Elettrovalvole a filtri Gas / Solenoid valves and Gaz filters / Electrovanne et filtres pour Gaz	<u>Pag</u> 28
>> Valvole miscelatrici e deviatrici / Mixing Valves / Vannes de melange	<u>Pag</u> 31
>> Valvole con attuatore / Actuator Valves / Vannes motorizées	<u>Pag</u> 34
>> Valvole industriali / Industrial Valves / Robinetterie industrielle	<u>Pag</u> 37
>> Staffaggi / Anchors and fixings / Supportage et chevillage	<u>Pag</u> 43
>> Valvole termosifone / Radiator Valves / Robinets radiateur	<u>Pag</u> 46
>> Accessori per valvole radiatore / Accessories for Radiator Valves / Accessoires pour vanne chauffage	<u>Pag</u> 51
>> Accessori per radiatori / Accessories for Panel radiator / Accessoires pour radiateur	<u>Pag</u> 53
>> Collettori / Manifolds / Collecteurs	<u>Pag</u> 55
>> Prodotti a sistemi per riscaldamento radiante/Heating floor systems and products/Produits plancher chauffant	<u>Pag</u> 59

VALVOLE A SFERA  
BALL VALVES  
ROBINETS A' BOISSEAU



VS—Valvole a sfera Serie "Silver" PN 25

VS—Ball Valves Serie "Silver" PN 25

VS—Vannes à boisseau spheriques Serie "Silver" PN 25

IT: Valvola a sfera passaggio standard F/F

EN: Ball valve standard bore F/F

FR: Vanne à boisseau passage standard FE/FE

**Art. VS 137**

Codice	Misura	Box	€
VSDI37005ARN	1/2"	160	4,04
VSDI37007ARN	3/4"	120	6,15
VSDI37010ARN	1"	60	10,08
VSDI37012ARN	1 1/4"	48	16,39
VSDI37015ARN	1 1/2"	24	24,78
VSDI37020ARN	2"	12	37,95



\*\*\*Disponibile maniglia in ferro (cod. .... FRN)  
\*\*\* Steel Handle Available (cod. ....FRN)

IT: Valvola a sfera passaggio standard F/F farfalla rossa

EN: Ball valve standard bore F/F butterfly handle

FR: Vanne à boisseau passage standard FE/FE manette papillon

**Art. VS 137P**

Codice	Misura	Box	€
VSDI37P05PRN	1/2"	160	4,04
VSDI37P07PRN	3/4"	120	6,15
VSDI37P10PRN	1"	60	10,08



IT: Valvola a sfera passaggio standard M/F

EN: Ball valve standard bore M/F

FR: Vanne à boisseau passage standard MA/FE

**Art. VS 137M**

Codice	Misura	Box	€
VSDI37M05ARN	1/2"	160	4,55
VSDI37M07ARN	3/4"	120	6,61
VSDI37M10ARN	1"	60	10,39



\*\*\*Disponibile maniglia in ferro (cod. .... FRN)  
\*\*\* Steel Handle Available (cod. ....FRN)

IT: Valvola a sfera passaggio standard M/F farfalla rossa

EN: Ball valve standard bore M/F butterfly handle

FR: Vanne à boisseau passage standard MA/FE manette papillon

**Art. VS 137MP**

Codice	Misura	Box	€
VSDI37MP05PRN	1/2"	160	4,55
VSDI37MP07PRN	3/4"	120	6,61
VSDI37MP10PRN	1"	60	10,39



IT: Valvola a sfera passaggio standard M/M

EN: Ball valve standard bore M/M

FR: Vanne à boisseau passage standard MA/MA

**Art. VS 138**

Codice	Misura	Box	€
VSDI38005ARN	1/2"	160	6,79
VSDI38007ARN	3/4"	120	9,48
VSDI38010ARN	1"	60	10,59



\*\*\*Disponibile maniglia in ferro (cod. .... FRN)  
\*\*\* Steel Handle Available (cod. ....FRN)

IT: Valvola a sfera passaggio standard M/M farfalla rossa

EN: Ball valve standard bore M/M butterfly handle

FR: Vanne à boisseau passage standard MA/MA manette papillon

**Art. VS 138P**

Codice	Misura	Box	€
VSDI38P05PRN	1/2"	160	6,79
VSDI38P07PRN	3/4"	120	9,48
VSDI38P10PRN	1"	60	10,59



**VS—Valvole a sfera Serie "Silver" PN 25**  
**VS—Ball Valves Serie "Silver" PN 25**  
**VS—Vannes à boisseau spheriques Serie "Silver" PN 25**

IT: Valvola a sfera passaggio integrale F/F  
 EN: Ball valve full bore F/F  
 FR: Vanne à boisseau passage intégrale FE/FE

IT: Valvola a sfera passaggio integrale F/F farfalla rossa  
 EN: Ball valve full bore F/F butterfly handle  
 FR: Vanne à boisseau passage integra FE/FE manette papillon

**Art. VS 141**

Codice	Misura	Box	€
VSDI41003ARN	3/8"	160	4,74
VSDI41005ARN	1/2"	160	4,74
VSDI41007ARN	3/4"	120	7,28
VSDI41010ARN	1"	60	11,55
VSDI41012ARN	1"1/4	48	17,85
VSDI41015ARN	1"1/2	24	25,87
VSDI41020ARN	2"	12	40,56
VSDI41025ARN	2"1/2	6	88,67
VSDI41030ARN	3"	2	165,26
VSDI41040ARN	4"	1	266,85



\*\*\*Disponibile maniglia in ferro (cod. .... FRN)  
 \*\*\* Steel Handle Available (cod. ....FRN)

**Art. VS 141P**

Codice	Misura	Box	€
VSDI41003PRN	3/8"	160	4,74
VSDI41005PRN	1/2"	160	4,74
VSDI41007PRN	3/4"	120	7,28
VSDI41010PRN	1"	60	11,55



IT: Valvola a sfera passaggio integrale M/F  
 EN: Ball valve full bore M/F  
 FR: Vanne à boisseau passage intégrale MA/FE

IT: Valvola a sfera passaggio integrale M/F farfalla rossa  
 EN: Ball valve full bore M/F butterfly handle  
 FR: Vanne à boisseau passage intégrale MA/FE manette papillon

**Art. VS 147**

Codice	Misura	Box	€
VSDI47003ARN	3/8"	160	4,77
VSDI47005ARN	1/2"	160	5,08
VSDI47007ARN	3/4"	120	7,78
VSDI47010ARN	1"	60	12,24
VSDI47012ARN	1"1/4	48	18,78
VSDI47015ARN	1"1/2	24	26,90
VSDI47020ARN	2"	12	43,34



\*\*\*Disponibile maniglia in ferro (cod. .... FRN)  
 \*\*\* Steel Handle Available (cod. ....FRN)

**Art. VS 147P**

Codice	Misura	Box	€
VSDI47005PRN	3/8"	160	4,77
VSDI47005PRN	1/2"	160	5,08
VSDI47007PRN	3/4"	120	7,78
VSDI47010PRN	1"	60	12,24



IT: Valvola a sfera passaggio integrale M/M  
 EN: Ball valve full bore M/M  
 FR: Vanne à boisseau passage intégrale MA/MA

IT: Valvola a sfera passaggio integrale M/M farfalla rossa  
 EN: Ball valve full bore M/M butterfly handle  
 FR: Vanne à boisseau passage intégrale MA/MA manette papillon

**Art. VS 148**

Codice	Misura	Box	€
VSDI48005ARN	1/2"	20	7,39
VSDI48007ARN	3/4"	15	10,30
VSDI48010ARN	1"	10	16,49



\*\*\*Disponibile maniglia in ferro (cod. .... FRN)  
 \*\*\* Steel Handle Available (cod. ....FRN)

**Art. VS 148P**

Codice	Misura	Box	€
VSDI48P05PRN	1/2"	25	7,39
VSDI48P07PRN	3/4"	20	10,30
VSDI48P10PRN	1"	15	16,49



IT: Valvola a sfera passaggio integrale M/F c/bocchettone diritta  
 EN: Ball valve full bore M/F with nut and tail  
 FR: Vanne à boisseau passage intégrale MA/FE avec douille

**Art. VS 146B**

Codice	Misura	Box	€
VSD146B05PRN	1/2"	120	7,79
VSD146B07PRN	3/4"	90	11,46
VSD146B10PRN	1"	60	17,59
VSD146B12PRN	1 1/4"	36	31,18



IT: Valvola a sfera passaggio integrale M/F c/bocchettone a squadra  
 EN: Ball valve full bore M/F angle pattern with nut and tail  
 FR: Vanne à boisseau passage integrale MA/FE avec douille èquerre

**Art. VS 146A**

Codice	Misura	Box	€
VSD146A05PRN	1/2"	90	9,96
VSD146A07PRN	3/4"	80	18,39
VSD146A10PRN	1"	40	26,56



IT: Valvola a sfera passaggio integrale F/F con spurgo  
 EN: Ball valve full bore F/F with drain  
 FR: Vanne à boisseau passage intégrale FE/FE à purge

**Art. VS 144**

Codice	Misura	Box	€
VSD144005ARN	1/2"	80	8,13
VSD144007ARN	3/4"	60	11,53
VSD1440010ARN	1"	40	16,28
VSD1440012ARN	1 1/4"	40	26,15
VSD1440015ARN	1 1/2"	20	35,36
VSD144020ARN	2"	10	61,23



\*\*\*Disponibile maniglia in ferro (cod. ....FRN)  
 \*\*\* Steel Handle Available (cod. ....FRN)

IT: Valvola a sfera a tre vie F/F/F flusso a L  
 EN: Three ways ball valves F/F/F L flow  
 FR: Vanne à boisseau passage a trois voies FE/FE/FE passaggè à L

**Art. VS 149A**

Codice	Misura	Box	€
VSD149A05ARN	1/2"	25	39,87
VSD149A07ARN	3/4"	20	48,33
VSD149A10ARN	1"	15	74,56
VSD149A12ARN	1 1/4"	5	102,37
VSD149A15ARN	1 1/2"	5	151,20
VSD149A20ARN	2"	1	246,74



\*\*\*Solo su ordinazione  
 \*\*\* Only on demand

IT: Valvola a sfera passaggio integrale F/F con attacco sonda  
 EN: Ball valve full bore F/F with probe connection  
 FR: Vanne à boisseau passage intégrale FE/FE avec branchement pour sonde

**Art. VS 341**

Codice	Misura	Box	€
VSD341005PRN	1/2"	20	
VSD341007PRN	3/4"	15	
VSD341010PRN	1"	10	



\*\*\*Solo su ordinazione  
 \*\*\* Only on demand

IT: Valvola a sfera pass. integrale attacco compressione tubo rame  
 EN: Ball valve full bore with copper compression end  
 FR: Vanne à boisseau passage intégrale à compression pour tube de cuivre

**Art. VS 173**

Codice	Misura	Box	€
VSB173015FRN	15	25	8,00
VSB173022FRN	22	15	12,10
VSB173028FRN	28	10	18,30



- VS—Valvole a sfera Serie “Silver” PN 25
- VS—Ball Valves Serie “Silver” PN 25
- VS—Vannes à boisseau spheriques Serie “Silver” PN 25

IT: Valvola a sfera ad incasso con cappuccio cromato F/F  
 EN: Ball valve full bore built-in F/F  
 FR: Vanne à boisseau passage intégrale à encasser FE/FE

**Art. VS 600**

Codice	Misura	Box	€
VAD60000500N	1/2"	10	15,57
VAD60000700N	3/4"	5	20,90



IT: Valvola a sfera ad incasso con maniglia cromata F/F  
 EN: Ball valve full bore built-in chromed handle F/F  
 FR: Vanne à boisseau passage intégrale à encasser avec menette FE/FE

**Art. VS 605**

Codice	Misura	Box	€
VAD60500500N	1/2"	8	15,98
VAD60500700N	3/4"	6	22,21



IT: Valvola a sfera INDIX 316 passaggio integrale F/F  
 EN: Stainless Steel Ball valve full bore F/F  
 FR: Vanne à boisseau acier INDX passage intégrale FE/FE

**Art. VSX 141**

Codice	Misura	Box	€
VSX141000200	1/4"	20	13,95
VSX141000300	3/8"	20	15,20
VSX141000500	1/2"	20	16,49
VSX141000700	3/4"	20	23,71
VSX141001000	1"	15	31,69
VSX141001200	1 1/4"	15	54,95
VSX141001500	1 1/2"	10	65,89
VSX141002000	2"	4	100,09
VSX141002500	2 1/2"	2	205,20
VSX141003000	3"	1	302,48



IT: Valvola a sfera a passaggio integrale applicazioni solare F/F  
 EN: Ball valve full bore F/F for Solar Applications  
 FR: Vanne à boisseau passage intégrale FE/FE haut temperature

**Art. VS 141S**

Codice	Misura	Box	€
VSD141SD5ARN	1/2"	20	12,00
VSD141SD7ARN	3/4"	20	17,00
VSD141SD10ARN	1"	20	26,00





VS—Valvole a sfera avanti contatore

VS—Ball Valves for counter meter

VS—Vannes à boisseau spheriques avant compteur

IT: Valvola a sfera avanti-contatore, Diritta femmina— Calotta libera  
 EN: Brass ball valve for water meter , Female straight — Swivel nut  
 FR: Vanne à sphère laiton pour , compteur d'eau — Droit femelle Ecrou prisonnier

IT: Valvola a sfera avanti - contatore , Diritta maschio - Calotta libera  
 EN: Brass ball valve for water meter, Male straight — Swivel nut  
 FR: Vanne à sphère laiton pour , compteur d'eau—Droit male Ecrou prisonnier

**Art. VS 720**

Codice	Misura	Box	€
VSD720050700	F 1/2" x 3/4"	10	9,50
VSD720070700	F 3/4" x 3/4"	10	9,88



\*\*\*Solo su ordinazione  
 \*\*\* Only on demand

**Art. VS 721**

Codice	Misura	Box	€
VSD721050700	M 1/2" x 3/4"	10	9,50
VSD721070700	M 3/4" x 3/4"	10	9,88



\*\*\*Solo su ordinazione  
 \*\*\* Only on demand

IT: Valvola a sfera avanti —contatore , Squadra femmina — Calotta libera  
 EN: Brass ball valve for water meter , Female angle — Swivel nut  
 FR: Vanne à sphère laiton pour , compter d'eau — Equerre femelle Ecrou prisonnier

IT: Valvola a sfera avanti — contatore , Squadra maschio — Calotta libera  
 EN: Brass ball valve for water meter , Male angle — Swivel nut  
 FR: Vanne à sphère laiton pour , compter d'eau — Equerre male Ecrou prisonnier

**Art. VS 722**

Codice	Misura	Box	€
VSD722050700	F 1/2" x 3/4"	10	11,46
VSD722070700	F 3/4" x 3/4"	10	12,54





\*\*\*Solo su ordinazione  
 \*\*\* Only on demand

**Art. VS 723**

Codice	Misura	Box	€
VSD723050700	M 1/2" x 3/4"	10	11,46
VSD723070700	M 3/4" x 3/4"	10	12,54



\*\*\*Solo su ordinazione  
 \*\*\* Only on demand

-  VS—Valvole a sfera Serie Gas - MOP 5
-  VS—Ball Valves Serie Gas- MOP 5
-  VS—Vannes à boisseau spheriques Serie Gaz - MOP 5

IT: Valvola sfera Gas passaggio integrale F/F a leva  
 EN: Gas ball valve full bore F/F  
 FR: Vanne à boisseau Gaz passage integrale FE/FE

IT: Valvola a sfera Gas passaggio integrale F/F a farfalla  
 EN: Gas ball valve bore F/F butterfly handle  
 FR: Vanne à boisseau Gaz passage integrale FE/FE manette papillon

**Art. VS 139**

Codice	Misura	Box	€
VSD139005FGN	1/2"	160	6,47
VSD139007FGN	3/4"	120	9,28
VSD139010FGN	1"	60	13,37
VSD139012FGN	1 1/4"	48	23,36
VSD139015FGN	1 1/2"	24	34,01
VSD139020FGN	2"	8	53,36
VSD139025FGN	2 1/2"	1	153,02



**Art. VS 139P**

Codice	Misura	Box	€
VSD139005PGN	1/2"	160	6,47
VSD139007PGN	3/4"	120	9,28
VSD139010PGN	1"	60	13,37



IT: Valvola a sfera Gas passaggio integrale M/F a leva  
 EN: Gas ball valve full bore M/F  
 FR: Vanne à boisseau Gaz passage integrale MA/FE

IT: Valvola a sfera Gas passaggio integrale M/F a farfalla  
 EN: Gas ball valve full bore M/F butterfly handle  
 FR: Vanne à boisseau Gaz passage integrale MA/FE manette papillon

**Art. VS 139M**

Codice	Misura	Box	€
VSD139M05FGN	1/2"	20	6,81
VSD139M07FGN	3/4"	15	10,02
VSD139M10FGN	1"	10	14,12



**Art. VS 139MP**

Codice	Misura	Box	€
VSD139M05PGN	1/2"	25	6,81
VSD139M07PGN	3/4"	20	10,02
VSD139M10PGN	1"	15	14,12



IT: Rubinetto a sfera Gas passaggio integrale a squadra M/F c/dado girevole  
 EN: Gas valve full bore angle pattern with turning nut  
 FR: Vanne à boisseau Gaz passage integrale èquerre avec ecrou tournant

IT: Rubinetto a sfera Gas passaggio integrale M/F a squadra  
 EN: Gas Ball valve full bore M/F angle pattern  
 FR: Vanne a boisseau Gaz passage integrale MA/FE èquerre

**Art. VS 183**

Codice	Misura	Box	€
VSD183005PGN	1/2"-1/2"	25	10,50
VSD183007PGN	1/2"-3/4"	20	11,50



**Art. VS 181**

Codice	Misura	Box	€
VSD181005PGN	1/2"	25	7,59
VSD181007PGN	3/4"	20	12,00



- VS—Valvole a sfera Serie Gas - MDP 5**
- VS—Ball Valves Serie Gas- MDP 5**
- VS—Vannes à boisseau spheriques Serie Gaz - MDP 5**

IT: Rubinetto a sfera Gas passaggio integrale M/M a squadra  
 EN: Gas ball valve full bore M/M angle pattern  
 FR: Vanne à boisseau Gaz passage integrale MA/MA èquerre

IT: Rubinetto a sfera Gas passaggio integrale a squadra F c/dado girevole  
 EN: Gas valve full bore angle pattern with turning nut  
 FR: Vanne à boisseau Gaz passage integrale èquerre avec ecrou tournant

**Art. VS 182**

Codice	Misura	Box	€
VSD182005PGN	1/2"	25	7,69
VSD182005PGN	3/4"	20	12,00



**Art. VS 184**

Codice	Misura	Box	€
VSD184005PGN	1/2"-1/2"	25	10,50
VSD184007PGN	3/4"-3/4"	25	15,50



IT: Valvola a sfera Gas diritta F/F c/Prova pressione a leva  
 EN: Gas ball valve F/F with pressure intake ports  
 FR: Vanne à boisseau Gaz F/F avec prises de pression

IT: Valvola a sfera Gas diritta M/F c/prova pressione a leva  
 EN: Gas ball valve M/F with pressure intake ports  
 FR: Vanne à boisseau Gaz M/F avec prises de pression

**Art. VSG 141**

Codice	Misura	Box	€
VSG141000005	1/2"	14	18,00
VSG141000007	3/4"	10	23,00
VSG141000010	1"	6	33,00
VSG141000012	1 1/4"	4	60,00



**Art. VSG 147**

Codice	Misura	Box	€
VSG147000005	1/2"	14	19,00
VSG147000007	3/4"	10	24,00
VSG147000010	1"	6	34,00
VSG147000012	1 1/4"	4	69,00



-  **VSB—Valvole a sfera Serie "Gold" PN 40**
-  **VSB—Ball Valves Serie "Gold" PN 40**
-  **VSB—Vannes à boisseau spheriques Serie "Gold" PN 40**

IT: Valvola a sfera passaggio integrale F/F maniglia a leva ISO 7  
 EN: Ball valve full bore F/F ISO 7  
 FR: Vannè à boisseau passage integrale FE/FE ISO 7

Art. VSB 141	Codice	Misura	Box	€
	VSB141005ANN	1/2"	20	7,31
	VSB141007ANN	3/4"	15	10,34
	VSB141010ANN	1"	10	15,95
	VSB141012ANN	1 1/4"	5	28,19
	VSB141015ANN	1 1/2"	5	39,39
	VSB141020ANN	2"	2	62,37
	VSB141025ANN	2 1/2"	2	140,00
	VSB141030ANN	3"	1	229,00

\*\*\*Disponibile maniglia in ferro (cod. ....FRN)  
 \*\*\* Steel Handle Available (cod. ....FRN)

IT: Valvola a sfera passaggio integrale F/F maniglia a farfalla ISO 7  
 EN: Ball valve full bore F/F butterfly handle ISO 7  
 FR: Vannè à boisseau passage integrale FE/FE manette papillon ISO 7

Art. VSB 141P	Codice	Misura	Box	€
	VSB141005PNN	1/2"	25	7,31
	VSB141007PNN	3/4"	20	10,34
	VSB141010PNN	1"	15	15,95

IT: Valvola a sfera passaggio integrale M/F maniglia a leva ISO 7  
 EN: Ball valve full bore M/F ISO 7  
 FR: Vannè à boisseau passage integrale MA/FE ISO 7

Art. VSB 147	Codice	Misura	Box	€
	VSB147005ANN	1/2"	20	8,12
	VSB147007ANN	3/4"	15	11,49
	VSB147010ANN	1"	10	17,53
	VSB147012ANN	1 1/4"	5	30,00
	VSB147015ANN	1 1/2"	5	45,00
	VSB147015ANN	2"	2	70,00

\*\*\*Disponibile maniglia in ferro (cod. ....FRN)  
 \*\*\* Steel Handle Available (cod. ....FRN)

IT: Valvola a sfera passaggio integrale M/F maniglia a farfalla ISO 7  
 EN: Ball valve full bore M/F butterfly handle ISO 7  
 FR: Vannè à boisseau passage integrale MA/FE manette papillon ISO/7

Art. VSB 147P	Codice	Misura	Box	€
	VSB147005PNN	1/2"	25	8,12
	VSB147007PNN	3/4"	20	11,49
	VSB147010PNN	1"	15	17,53

IT: Valvola a sfera passaggio integrale c/bocchettone diritta  
 EN: Ball valve full bore with nut and tail butterfly handle  
 FR: Vannè à boisseau passage integrale avec douille et manette papillon

Art. VSB 146B	Codice	Misura	Box	€
	VSB146B05PNN	1/2"	25	10,66
	VSB146B07PNN	3/4"	20	15,12
	VSB146B10PNN	1"	15	23,49

IT: Valvola a sfera passaggio integrale c/bocchettone a squadra  
 EN: Ball valve full bore with nut and tail angle pattern butterfly handle  
 FR: Vannè à boisseau passage integrale avec douille èquerre manette papillon

Art. VSB 146A	Codice	Misura	Box	€
	VSB146A05PNN	1/2"	25	13,24
	VSB146A07PNN	3/4"	20	19,37
	VSB146A10PNN	1"	15	31,55

**RIDUTTORI DI PRESSIONE**  
**PRESSURE REDUCING VALVES**  
**REDUCTEURS DE PRESSION**





**RD— Riduttore di pressione**  
**RD— Pressure reducing valves**  
**RD— Reducteurs de pression**

IT: Riduttore di pressione Femmina Sede Acciaio Inox PN25  
 EN: Pressure reducer female Stainless Steel set PN25  
 FR: Reducteur de pression femelle avec siège en acier Inox PN25

**Art. RD 130**

Codice	Misura	Box	€
R00013005000	1/2"	1	42,00
R00013007000	3/4"	1	56,00
R00013010000	1"	1	71,00
R00013012000	1 1/4"	1	138,00
R00013015000	1 1/2"	1	157,00
R00013020000	2"	1	239,00
R00013025000	2 1/2"	1	319,00
R00013030000	3"	1	440,00
R00013040000	4"	1	850,00



IT: Riduttore di Pressione c/Bocchettone Maschio Sede Acciaio Inox PN25  
 EN: Pressure reducer male with nut and tail Stainless Steel set PN25  
 FR: Reducteur de pression male avec douille et siège en acier Inox PN25

**Art. RD 140**

Codice	Misura	Box	€
R00014005000	1/2"	1	54,00
R00014007000	3/4"	1	69,00
R00014010000	1"	1	84,00
R00014012000	1 1/4"	1	158,00
R00014015000	1 1/2"	1	178,00
R00014020000	2"	1	272,00



IT: Riduttore di Pressione Femmina Serie Mini PN15  
 EN: Pressure reducer female Mini Series PN15  
 FR: Reducteur de pression femelle mini-série PN15

**Art. RD 150**

Codice	Misura	Box	€
R00015003000	3/8"	1	18,00
R00015005000	1/2"	1	18,00
R00015007000	3/4"	1	19,00



IT: Riduttore di Pressione M/M Serie Mini PN15  
 EN: Pressure reducer male Mini Series PN15  
 FR: Reducteur de pression male mini-série PN15

**Art. RD 151**

Codice	Misura	Box	€
R00015105000	1/2"	1	18,00
R00015107000	3/4"	1	19,00



IT: Gruppo Carico Impianto Filtro e Dispositivo non Ritorno Integrato  
 EN: Fillings units with integrated non-return device  
 FR: Système de chargement avec filtre et dispositif de non-retour

**Art. RD 105**

Codice	Misura	Box	€
R00105005000	1/2"	1	47,00



Manometro a richiesta

IT: Riduttore di Pressione Maschio con calotta girevole Serie Mini PN15  
 EN: Pressure reducer male Mini Series PN15 with turnable nut  
 FR: Reducteur de pression male mini-série PN15 avec ecrou tournant

**Art. RD 104**

Codice	Misura	Box	€
R00104007070	3/4"-3/4"	1	22,00



IT: Riduttore di pressione c/Bocchettone Femmina Sede Acciaio Inox PN40  
 EN: Pressure reducer female with nut and tail Stainless Steel stem PN40  
 FR: Reducteur de pression femelle avec douille et siège en acier Inox PN40

### Art. RD 120

Codice	Misura	Box	€
RDD012005000	1/2"	1	66,00
RDD012007000	3/4"	1	86,00
RDD012010000	1"	1	118,00



IT: Filtro Autopulente 100micron PN25  
 EN: Self clearing filter 100micron PN25  
 FR: Filtre auto-nettoyage 100micron PN25

### Art. RD 159

Codice	Misura	Box	€
RDD159005000	1/2"	1	122,00
RDD159007000	3/4"	1	122,00
RDD159010000	1"	1	133,00
RDD159012000	1 1/4"	1	139,00
RDD159015000	1 1/2"	1	172,00
RDD159020000	2"	1	185,00



IT: DEFANGATORE in ottone PN 10 cartuccia acciaio inox temp. Max 130°  
 EN: Deposit separator brass PN10 inox cartridge Max temp. 130°  
 FR: Séparateur de boues laiton PN10 cartouche acier Max temp. 130°

### Art. FC 114

Codice	Misura	Box	€
FC0114000007	3/4"	1	80,00
FC0114000010	1"	1	85,00
FC0114000012	1 1/4"	1	111,00
FC0114000015	1 1/2"	1	116,00
FC0114000020	2"	1	123,00



Magnetico  
Art. FC 116

IT: DEFANGATORE/DISAREATORE in ottone con Valvola Sfogo Aria da 3/8"  
 EN: Deposit separator /air separator brass with air release valve 3/8"  
 FR: Séparateur de boues/désaérateur laiton avec air purgeur 3/8"

### Art. FC 115

Codice	Misura	Box	€
FC0115000007	3/4"	1	88,00
FC0115000010	1"	1	92,00
FC0115000012	1 1/4"	1	118,00
FC0115000015	1 1/2"	1	123,00



IT: Valvola Ammortizzatore Colpo D'Ariete max 90° 40bar  
 EN: Shock absorber anti-water hammer max 90° 40bar  
 FR: Amortisseur coups de béliet max 90° 40bar

### Art. RD 17

Codice	Misura	Box	€
RDD170005000	1/2"	10	22,00



IT: Manometro Attacco Posteriore /Radiale  
 EN: Pressure gauge Back/Radial connection  
 FR: Manomètre Postérieur /Radial

### Art. RD 15/16

Codice	Misura	Box	€
MID150000200 posteriore	1/4"	10	6,00
MID160000200 radiale	1/4"	10	6,00



**PRODOTTI COMPLEMENTARI ACQUA**  
**VARIOUS WATER PRODUCTS**  
**PRODUITS DIVERS POUR L'EAU**





IT: Rubinetto sottolavabo lungo  
 EN: Under washbasin long type  
 FR: Robinet sous lavabo long

**Art. PI 88**

Codice	Misura	Box	€
PI0088000510	1/2" x 10	25	4,89



IT: Rubinetto sottolavabo a sfera c/filtro  
 EN: Under washbasin bibcock with filter  
 FR: Robinet sous lavabo avec filtre

**Art. PI 89**

Codice	Misura	Box	€
PI0089000510	1/2 x 10	25	7,86



IT: Rubinetto lavatrice con rosetta  
 EN: Washing machine tap with rosette  
 FR: Robinet machine à laver avec rosette

**Art. PI 299**

Codice	Misura	Box	€
PI029900505C	1/2" - 1/2"	20	6,50
PI029900507C	1/2" - 3/4"	15	6,91



IT: Rubinetto doppio attacco lavatrice con ogiva  
 EN: Double under washbasin bibcock with washing machine connection with brass olive  
 FR: Double branchement machine à laver robinet avec olive laiton

**Art. PI 300**

Codice	Misura	Box	€
PI030000507C	1/2" - 3/4" X 10	25	14,80



IT: Rubinetto lavatrice con maniglia tre punte  
 EN: Washing machine tap triangle handle  
 FR: Robinet machine à laver poignée triangulaire

**Art. PI 297**

Codice	Misura	Box	€
PI029700507C	1/2" - 3/4"	15	6,45



IT: Rubinetto lavatrice obliquo  
 EN: Washing machine tap inclined  
 FR: Robinet machine à laver oblique

**Art. PI 296**

Codice	Misura	Box	€
PI029600507C	1/2" - 3/4"	15	6,87



IT: Rubinetto da giardino  
 EN: Hose bib cock  
 FR: Robinet d'arrosage

**Art. PI 136**

Codice	Misura	Box	€
PI013600500N	3/4" - 1/2"	25	5,49
PI013600700N	1" - 3/4"	20	7,15



IT: Rubinetto da giardino con maniglia luchettabile  
 EN: Hose bib cock lockable pattern  
 FR: Robinet d'arrosage poignée plombable

**Art. PI 134**

Codice	Misura	Box	€
PI013400500N	3/4" - 1/2"	25	7,45



IT: Rubinetto a collo in ottone cromato con portagomma  
 EN: Neck Hose bib cock chromed brass  
 FR: Robinet raccord au nez en laiton chromé

**Art. PI 132**

Codice	Misura	Box	€
PI013200500N	3/4" - 1/2"	20	9,30



IT: Rubinetto a collo in ottone giallo con portagomma  
 EN: Neck Hose bib cock yellow polished brass  
 FR: Robinet raccord au nez en laiton brillant

**Art. PI 133**

Codice	Misura	Box	€
PI013300500N	3/4" - 1/2"	20	12,83



IT: Prolunga ridotta cromata con dado  
 EN: Chromium plated reduced extension with nut  
 FR: Extension réduite chrome avec écrou

**Art. PI 5006**

Codice	Misura	Box	€
PI0500600510	1/2" x 10	25	3,60



IT: Curvetta a 90°  
 EN: Chrome copper elbow 90°  
 FR: Coude chromé 90°

**Art. PI 5007**

Codice	Misura	Box	€
PI0500700510	1/2" x 10	25	6,50



IT: Valvola di ritengo con disco in Nylon  
 EN: Check valve with shutter in Nylon  
 FR: Clapet antiretour avec obturater en Nylon

**Art. PI 65D**



Codice	Misura	Box	€
PI0650005000	1/2"	30	4,80
PI0650007000	3/4"	25	6,82
PI0650010000	1"	15	9,15
PI0650012000	1 1/4"	10	13,24
PI0650015000	1 1/2"	10	18,31
PI0650020000	2"	5	27,73

IT: Valvola di ritengo pesante con otturatore in ottone  
 EN: Heavy Check valve with Brass shutter  
 FR: Clapet antiretour avec obturateur en laiton

**Art. PI 65DS**



Codice	Misura	Box	€
PI0650S05000	1/2"	30	7,80
PI0650S07000	3/4"	25	10,36
PI0650S10000	1"	15	15,10
PI0650S12000	1 1/4"	10	22,76
PI0650S15000	1 1/2"	10	29,95
PI0650S20000	2"	5	47,74
PI0650S25000	2 1/2"	1	107,79
PI0650S30000	3"	1	161,50
PI0650S40000	4"	1	235,73

IT: Valvola a clapet sede in metallo (disponibile con sede gomma Art. 400G)  
 EN: Clapet valve metal seat (Rubber seat available Art. 400G)  
 FR: Vannè à clapet avec siège metal (Disponibile avec siège élastomère Art.400G)

**Art. PI 400**



Codice	Misura	Box	€
PI0400005000	1/2"	20	7,49
PI0400007000	3/4"	15	10,18
PI0400010000	1"	10	15,01
PI0400012000	1 1/4"	5	19,82
PI0400015000	1 1/2"	5	29,60
PI0400020000	2"	1	41,36
PI0400025000	2 1/2"	1	66,59
PI0400030000	3"	1	96,68
PI0400040000	4"	1	156,84

IT: Valvola di fondo con filtro in ottone  
 EN: Foot valve with brass strainer  
 FR: Vanne crepine avec filtre en laiton

**Art. PI 450**



Codice	Misura	Box	€
PI0450007000	3/4"	20	10,10
PI0450010000	1"	15	12,56
PI0450012000	1 1/4"	10	19,61
PI0450015000	1 1/2"	5	25,37
PI0450020000	2"	1	38,44
PI0450025000	2 1/2"	1	56,51
PI0450030000	3"	1	68,32
PI0450040000	4"	1	135,58

IT: Saracinesca filettata F/FPN 16  
 EN: Gate valve threaded pattern F/F PN 16  
 FR: Vanne a passage direct FE/FE PN 16

**Art. VA 231**



Codice	Misura	Box	€
VA0231005000	1/2"	20	7,15
VA0231007000	3/4"	15	9,83
VA0231010000	1"	10	12,81
VA0231012000	1 1/4"	5	19,45
VA0231015000	1 1/2"	5	24,52
VA0231020000	2"	5	36,82
VA0231025000	2 1/2"	1	54,08
VA0231030000	3"	1	67,39
VA0231040000	4"	1	117,55

IT: Filtro ad impurità ad Y ottone  
 EN: Y filter  
 FR: Filtre Y Laiton

**Art. PI 656**



Codice	Misura	Box	€
PI0656005000	1/2"	25	4,86
PI0656007000	3/4"	20	8,22
PI0656010000	1"	15	11,65
PI0656012000	1 1/4"	10	19,33
PI0656015000	1 1/2"	5	23,93
PI0656020000	2"	1	42,94
PI0656025000	2 1/2"	1	73,58
PI0656030000	3"	1	136,56
PI0656040000	4"	1	195,82

IT: Valvola a sfera Attacco Pompa a Stringere  
 EN: Pump valve compression pattern  
 FR: Vanne à boisseau pour circuler d'eau à compression

**Art. VS 303**

Codice	Misura	Box	€
VSD303022015	22 x 1"1/2	10	12,84
VSD303028015	28 x 1"1/2	5	15,60



IT: Valvola a sfera attacco pompa filettato  
 EN: Pump valve threaded pattern F/F  
 FR: Vanne à boisseau pour circuler d'eau FE/FE

**Art. VS 304**

Codice	Misura	Box	€
VSD304007015	3/4" x 1"1/2	10	12,81
VSD304010015	1" x 1"1/2	5	13,55



IT: Valvola di sicurezza attacco femmina (3-6 bar)  
 EN: Safety valve female end (3-6 bar)  
 FR: Vanne de sureté lien femelle (3-6 bar)

**Art. VA 60**

Codice	Misura	Box	€
VA0060000503	1/2" - 3b	10	6,35
VA0060000506	1/2" - 6b	10	6,35
VA0060000703	3/4" - 3b	10	9,00
VA0060000706	3/4" - 6b	10	9,00
VA0060001003	1" - 3b	10	19,00
VA0060001006	1" - 6b	10	19,00



Solare termico  
a richiesta

IT: Valvola di sicurezza attacco maschio (3-6 bar)  
 EN: Safety valve male end (3-6 bar)  
 FR: Vanne de sureté lien male (3-6 bar)

**Art. VA 61**

Codice	Misura	Box	€
VA0061000503	1/2" - 3b	10	6,60
VA0061000506	1/2" - 6b	10	6,60



IT: Valvola di sicurezza tarabile (1-9 bar)  
 EN: Safety valve conveyed discharge (1-9 bar)  
 FR: Vanne de sureté avec vidange véhiculée (1-9 bar)

**Art. VA 58**

Codice	Misura	Box	€
VA0058000005	1/2"	10	29,49
VA0058000007	3/4"	10	39,12
VA0058000010	1"	10	52,17
VA0058000012	1"1/4	5	86,37
VA0058000015	1"1/2	5	110,48
VA0058000020	2"	1	150,66



Altre misure a richiesta

IT: Valvola di sicurezza a membrana ISPEL (2,7-6 bar)  
 EN: Adjustable safety valve ISPEL (2,7-6 bar)  
 FR: Vanne de sureté à membrane ISPEL (2,7-6 bar)

**Art. VA 59**

Codice	Misura	Box	€
VA00590005..	1/2" - 3/4"	1	79,54
VA00590007..	3/4" - 1"	1	114,16
VA00590010..	1" - 1"1/4	1	229,53
VA00590012..	1"1/4 - 1"1/2	1	392,27



Specificare taratura in fase d'ordine

IT: Valvola di sfogo aria automatica  
 EN: Automatic air-discharger valve  
 FR: Air purgeur automatique

**Art. VA 110**

Codice	Misura	Box	€
VAD110000300	3/8"	10	6,90
VAD110000500	1/2"	10	6,90
VAD110000700	3/4"	10	7,83
VAD110001000	1"	10	9,00



IT: Valvola di sfogo aria automatica per impianti solari  
 EN: Automatic air-discharger valve for solar plants  
 FR: Air purgeur automatique pour solaire

**Art. VAX 110**

Codice	Misura	Box	€
VAX011000300	3/8"	10	14,50
VAX011000500	1/2"	10	15,50



IT: Valvola di sfogo aria automatica attacco 90°  
 EN: Automatic air-discharge valve 90°  
 FR: Air purgeur automatique 90°

**Art. VA 63**

Codice	Misura	Box	€
VA0063000030	3/8"	10	7,87
VA0063000050	1/2"	10	7,87



IT: Scarico caldaia con portagomma attacco maschio  
 EN: Drain cock for boiler male end  
 FR: Robinet de vidange male

**Art. PI 96**

Codice	Misura	Box	€
PI0096005000	1/2"	10	6,00



IT: Portamanometro M/F con flangia  
 EN: Manometer holder M/F with flange  
 FR: Robinet porte-manomètre MA/FE avec bride

**Art. SP 100**

Codice	Misura	Box	€
SP0100000200	1/4"	20	10,17
SP0100000300	3/8"	20	11,45
SP0100000500	1/2"	20	12,72



IT: Portamanometro M/F  
 EN: Manometer holder M/F  
 FR: Robinet porte-manomètre MA/FE

**Art. SP 101**

Codice	Misura	Box	€
SP0101000200	1/4"	20	6,54
SP0101000300	3/8"	20	6,90
SP0101000500	1/2"	20	7,27





- PI**— Prodotti complementari acqua
- PI**— Various water products
- PI**— Produits divers pour l'eau

IT: Portamanometro F/F  
 EN: Manometer holder F/F  
 FR: Robinet porte-manomètre FE/FE

**Art. SP 102**

Codice	Misura	Box	€
<u>SP0102000200</u>	<u>1/4"</u>	<u>20</u>	<u>6,54</u>
<u>SP0102000300</u>	<u>3/8"</u>	<u>20</u>	<u>6,90</u>
<u>SP0102000500</u>	<u>1/2"</u>	<u>20</u>	<u>7,27</u>



IT: Ricciolo per manometro  
 EN: Manometer curls  
 FR: Boucle en cuivre chrome

**Art. SP 103**

Codice	Misura	Box	€
<u>SP0103000200</u>	<u>1/4"</u>	<u>20</u>	<u>8,75</u>
<u>SP0103000300</u>	<u>3/8"</u>	<u>20</u>	<u>9,28</u>
<u>SP0103000500</u>	<u>1/2"</u>	<u>20</u>	<u>10,85</u>



IT: Rubinetto spurgo con porta gamma 90°  
 EN: Drain valve with hose union 90°  
 FR: Robinet de purge èquerre 90°

**Art. SP 150**

Codice	Misura	Box	€
<u>SP0150000100</u>	<u>1/4"</u>	<u>20</u>	<u>2,40</u>



IT: Mini Mignon M/M  
 EN: Mini Ball Valve Mignon M/M  
 FR: Mignon M/M

**Art. PI 98**

Codice	Misura	Box	€
<u>PI0098000500</u>	<u>1/2"</u>	<u>20</u>	<u>4,50</u>



IT: Minivalvola F/F  
 EN: Mini valve F/F  
 FR: Vanne mignon FE/FE

**Art. PI 99F**

Codice	Misura	Box	€
<u>PI0099F00300</u>	<u>1/4"</u>	<u>30</u>	<u>3,65</u>
<u>PI0099F00300</u>	<u>3/8"</u>	<u>25</u>	<u>3,65</u>
<u>PI0099F00500</u>	<u>1/2"</u>	<u>20</u>	<u>4,30</u>



**Serie pesante**  
**Art PI99FS**

IT: Minivalvola M/F  
 EN: Mini valve M/F  
 FR: Vanne mignon MA/FE

**Art PI 99M**

<u>PI0099M00200</u>	<u>1/4"</u>	<u>30</u>	<u>3,36</u>
<u>PI0099M00300</u>	<u>3/8"</u>	<u>25</u>	<u>3,36</u>
<u>PI0099M00500</u>	<u>1/2"</u>	<u>20</u>	<u>4,15</u>
<u>PI0099M00500</u>	<u>3/4"</u>	<u>10</u>	<u>7,32</u>



**Serie pesante**  
**Art PI99MS**

STRUMENTI DI MISURAZIONE E INTERCETTAZIONE  
MEASURING COMPONENTS  
INSTRUMENT DE MESURE





IT: Manometro attacco Radiale scala 0/10 bar  
 EN: Pressure gauge vertical connection 0/10 bar  
 FR: Manomètre lien radial 0/10 bar

**Art. MI 629**

Codice	Misura	Box	€
MI0629102063	1/4" - 63	25	8,50
MI0629103080	3/8" - 80	25	13,44
MI0629105100	1/2" - 100	25	17,50



IT: Manometro attacco Radiale scala 0/6 bar  
 EN: Pressure gauge vertical connection 0/6 bar  
 FR: Manomètre lien radial 0/6 bar

**Art. MI 629S**

Codice	Misura	Box	€
MI0629S62063	1/4" - 63	25	8,50
MI0629S63080	3/8" - 80	25	13,44
MI0629S65100	1/2" - 100	25	17,50



IT: Termometro attacco Radiale ISPESEL ø80 0-120°C  
 EN: Vertical thermometer ISPESEL ø80 0-120°C  
 FR: Thermomètre vertical ISPESEL ø80 0-120°C

**Art. MI 630**

Codice	Misura	Box	€
MI0630005050	1/2" x 50	25	27,10
MI0630005100	1/2" x 100	25	29,10



IT: Termometro attacco Radiale ø80 -30° +50°C  
 EN: Vertical thermometer ø80 -30° +50°C  
 FR: Thermomètre vertical ø80 -30° +50°C

**Art. MI 630V**

Codice	Misura	Box	€
MI0630V05050	1/2" x 50	25	28,46
MI0630V05100	1/2" x 100	25	30,56



IT: Termometro attacco Posteriore ø80 0-120°C  
 EN: Back stern equipped thermometer ø80 0-120°C  
 FR: Thermomètre posterieur ø80 0-120°C

**Art. MI 631**

Codice	Misura	Box	€
MI0631005050	1/2" x 50	25	9,70
MI0631005100	1/2" x 100	25	10,60



IT: Termometro attacco Posteriore ø80 -30° +50°C  
 EN: Back stern equipped thermometer ø80 -30° +50°C  
 FR: Thermomètre posterieur ø80 -30° +50°C

**Art. MI 631V**

Codice	Misura	Box	€
MI0631V05050	1/2" x 50	25	10,20
MI0631V05100	1/2" x 100	25	12,80





IT: Pozzetto per termometro  
 EN: Brass testing pocket  
 FR: Forreau pour sonde

**Art. MI 635**

Codice	Misura	Box	€
MIO635005050	1/2" x 50	20	4.85
MIO635005100	1/2" x 100	20	7.05



IT: Manometro c/GLICERINA attacco Radiale Ø63 del 1/4"  
 EN: Pressure Gauge vertical connection Glycerine Ø63 -1/4"  
 FR: Manomètre lien radial Glycérine Ø63 -1/4"

**Art. MI 627**

Codice	Misura	Box	€
MIO627C00042	0/4bar	25	18,55
MIO627C00062	0/6bar	25	18,55
MIO627C00102	0/10bar	25	18,55
MIO627C00162	0/16bar	25	18,55
MIO627C00252	0/25bar	25	18,55
MIO627C00402	0/40bar	25	18,55
MIO627C00602	0/60bar	25	18,55



IT: IDROMETRO attacco Radiale Ø80 del 3/8"  
 EN: Hydrometer vertical connection Ø80-3/8"  
 FR: Hidromètre lien radial Ø80-3/8"

**Art. MI 620**

Codice	Misura	Box	€
MIO620003016	0/16	25	18,60
MIO620003025	0/25	25	18,60
MIO620003040	0/40	25	18,60

Metri acqua



IT: Manometro x GAS attacco Radiale Ø63 1/4"  
 EN: Pressure gauge vertical connection Gas Ø63 1/4"  
 FR: Manomètre lien radial Gaz Ø63 1/4"

**Art. MI 626**

Codice	Misura	Box	€
MIO626C00602	0/60	25	43,09
MIO626C01002	0/100	25	43,09
MIO626C02502	0/250	25	43,09

mbar



Altre misure a richiesta



IT: Pressostato di Sicurezza Ispesl Riarmo Manuale 1-5bar  
 EN: Manual reset safety pressure switch type  
 FR: Pressure de surète à re-armement manuel

**Art. MI 632**

**Codice**

**Misura**

**Box**

**€**

M10632000100

1/4"

1

38.69



IT: Termostato Immersione Regolabile 0-90°C  
 EN: Immersion regulation thermostat encased  
 FR: Thermostat à immersion range 0-90°C

**Art. MI 633**

**Codice**

**Misura**

**Box**

**€**

M10633000500

1/2"

1

45.85



IT: Bitermostato Immersione Regolatore Manuale 0/90°  
 EN: Immersion control/limit thermostat with reset button  
 FR: Bi-Thermostat à immersion à rearmement manuel range 0/90°

**Art. MI 639**

**Codice**

**Misura**

**Box**

**€**

M10639000500

1/2"

1

83.20



IT: Termostato a Contatto Bimetallico tre contatti 20/90°  
 EN: Con tact bimetal thermostat encased with 3 con cats  
 FR: Thermostat à con tact bimetallic rang 20/90°

**Art. MI 419**

**Codice**

**Misura**

**Box**

**€**

M10419000500

1/2"

1

32.35



IT: Flussostato per Tubazioni da 1" - 8"  
 EN: Flow meter for pipes 1" - 8"  
 FR: Aqstatat pour tube 1" - 8"

**Art. MI 634**

**Codice**

**Misura**

**Box**

**€**

M10634000010

1"

1

120.50



IT: Pozzetto per sonda Ø-10  
 EN: Probe Pocket  
 FR: Forreau pour sonde Ø-10

**Art. MI 637**

**Codice**

**Misura**

**Box**

**€**

M10637005100

1/2"-100

25

8.07

M10637005150

1/2"-150

25

13.10

M10637005200

1/2"-200

25

13.88



IT: Termostato Immersione Regolatore Riarmo Manuale 100° INAIL  
 EN: Immersion regulation thermostat encased 0-100°C INAIL  
 FR: Thermostat à immersion range 0-100°C INAIL

IT: Pressostato Minima Riarmo Manuale Ispesl Regolazione 0,5/1,7 bar  
 EN: Manual reset low pressure switch  
 FR: Pressostat de minimum a rearment manuel range 0,5/1,7 bar

**Art. MI 420**

**Codice** MIO420000500 **Misura** 1/2" **Box** 1 **€** 47,90



**Art. MI 638**

**Codice** MIO638000100 **Misura** 1/4" **Box** 1 **€** 57,35



IT: Cronotermostato Elettronico digitale riscaldamento e condizionamento  
 EN: Digital Electronic chronothermostat suitable for heating and air conditioning  
 FR: Chrono Thermostat d'ambiance pour chauffage et climatisation

IT: Termostato Ambiente Elettromeccanico con spia  
 EN: Mechanical room Thermostat with warning light  
 FR: Thermostat ambiance manuel

**Art. MI 417**

**Codice** MIO417000000 **Versione** Touch screen **Box** 1 **€** 126,50



**Art. MI 418**

**Codice** MIO418000000 **Versione**  **Box** 1 **€** 30,00



ELETTROVALVOLE, FILTRI GAS ACCESSORI CENTRALE TERMICA  
SOLENOID VALVES, GAS FILTERS AND ACCESSORIES  
ELECTROVANNES, FILTRES GAZ ET ACCESSORIES



IT: Elettrovalvola Gas normal, Chiusa Riarmo Manuale 230V ingresso 550Mbar  
 EN: Gas solenoid valve normally closed manual reset 230V max intel 550Mbar  
 FR: Vanne solénoïde normal, fermè rèarmement manuel pression maximale 550Mbar

IT: Elettrovalvola Gas normal, Aperta Riarmo Manuale 230V ingresso 550Mbar  
 EN: Gas solenoid valve normally open manual reset 230V max intel 550Mbar  
 FR: Vanne solénoïde normal, ouverte rèarmement manuel pression maximale 550Mbar

**Art. FC 640**



Codice	Misura	Box	€
FC0640000005	1/2"	1	99,74
FC0640000007	3/4"	1	99,74
FC0640000010	1"	1	105,05
FC0640000012	1 1/4"	1	183,54
FC0640000015	1 1/2"	1	190,79
FC0640000020	2"	1	255,99
FC0640000065	DN 65	1	633,65
FC0640000080	DN 80	1	800,40
FC0640000100	DN 100	1	1245,45

**Art. FC 641**



Codice	Misura	Box	€
FC0641000005	1/2"	1	79,21
FC0641000007	3/4"	1	79,21
FC0641000010	1"	1	86,94
FC0641000012	1 1/4"	1	132,58
FC0641000015	1 1/2"	1	136,22
FC0641000020	2"	1	207,35
FC0641000065	DN 65	1	473,34
FC0641000080	DN 80	1	554,99
FC0641000100	DN 100	1	994,98

IT: Filtro per Gas omologato CE  
 EN: Gas filter CE mark  
 FR: Filtre à gaz avec approuvè CE

IT: Filtro Regolatore Gas a Chiusura omologata CE  
 EN: Gas regulator filter shut-off type CE mark  
 FR: Filtre regulateur gaz à fermeture approuvè CE

**Art. FC 642**



Codice	Misura	Box	€
FC0642000005	1/2"	1	17,31
FC0642000007	3/4"	1	17,31
FC0642000010	1"	1	35,02
FC0642000012	1 1/4"	1	56,38
FC0642000015	1 1/2"	1	56,38
FC0642000020	2"	1	75,11
FC0642000065	DN 65	1	349,93
FC0642000080	DN 80	1	397,27
FC0642000100	DN 100	1	662,92

**Art. FC 643**



Codice	Misura	Box	€
FC0643000007	3/4"	1	80,66
FC0643000010	1"	1	80,66
FC0643000012	1 1/4"	1	182,10
FC0643000015	1 1/2"	1	196,13
FC0643000020	2"	1	306,71
FC0643000065	DN 65	1	1007,06
FC0643000080	DN 80	1	1106,07
FC0643000100	DN 100	1	1643,41

IT: Valvola Intercett. Combustibile ISPEL azione Positiva Riarmo Manuale  
 EN: Manual reset fuel on-off valve type-tested and adjuste ISPEL  
 FR: Vanne d'interception combustibile rèarmement manuel ISPEL

IT: Valvola Scarico Termico ISPEL azione Positiva Riarmo Manuale Segnale Ottico  
 EN: Manual reset temperature relief valve fitted with warning light  
 FR: Vanne de rejet thermique rèarmement manuel avec signal optique

**Art. FC 644**



Codice	Misura	Box	€
FC0644000005	1/2"	1	349,70
FC0644000007	3/4"	1	415,01
FC0644000010	1"	1	434,70
FC0644000012	1 1/4"	1	575,50
FC0644000015	1 1/2"	1	632,08
FC0644000020	2"	1	768,92
FC0644000065	DN 65	1	1415,82
FC0644000080	DN 80	1	2042,20
FC0644000100	DN 100	1	2593,50

**Art. FC 206**



Codice	Misura	Box	€
FC0206000012	1 1/4"	1	589,68
FC0206000015	1 1/2"	1	853,20

IT: Giunto antivibrante Gas M/M 0.5bar  
EN: Stainless Steel vibration camper for Water /Gas M/M  
FR: Compensateur acier Eau/Gaz Filetè Male

Art. FC 187	Codice	Misura	Box	€
	FC0187000500	1/2"	1	14,99
	FC0187000700	3/4"	1	16,86
	FC0187001000	1"	1	22,30
	FC0187001200	1 1/4"	1	31,22
	FC0187001500	1 1/2"	1	38,95
	FC0187002000	2"	1	51,14



IT: Giunto antivibrante Gas flangiato 0.5bar  
EN: Stainless Steel vibration camper for Water /Gas flanged pattern  
FR: Compensateur acier Eau /Gaz à brides

Art. FC 188	Codice	Misura	Box	€
	FC0188000065	DN 65	1	181,68
	FC0188000080	DN 80	1	228,48
	FC0188000100	DN 100	1	274,18



IT: Giunto Dielettrico per gas filettato M/F  
EN: Dielectric transitino fitting M/F for gas  
FR: Joint de transitino diélectrique M/F pour Gaz

Art. PL 054	Codice	Misura	Box	€
	PL0540000005	1/2"	1	25,04
	PL0540000007	3/4"	1	25,04
	PL0540000010	1"	1	28,38
	PL0540000012	1 1/4"	1	39,23
	PL0540000015	1 1/2"	1	46,75
	PL0540000020	2"	1	60,94
	PL0540000025	2 1/2"	1	146,08
	PL0540000030	3"	1	208,69
	PL0540000040	4"	1	366,46



IT: Disaeratore per Impianto Riscaldamento  
EN: Dearator for heating system  
FR: Dégazeur pour installation chauffage

Art. FC 150	Codice	Misura	Box	€
	FC0150000010	1"	1	336,63
	FC0150000012	1 1/4"	1	352,89
	FC0150000015	1 1/2"	1	442,18
	FC0150000020	2"	1	576,72
	FC0150000065	dn 65	1	795,78
	FC0150000080	dn 80	1	1167,23



IT: Compensatore Idraulico per Impianto Riscaldamento  
EN: Hydraulic compensator for heating system  
FR: Compensateur hydraulique pour chauffage

Art. CS 112C	Codice	Misura	Box	€
	CS112C003010	3" x 1"	1	300,36
	CS112C004012	4" x 1 1/4"	1	399,88
	CS112C004015	4" x 1 1/2"	1	442,15
	CS112C005020	5" x 2"	1	494,06
	CS112C006065	6" x dn65	1	1075,33
	CS112C008080	8" x dn80"	1	1399,23
	CS112C003100	10" x dn100	1	2079,50



Con Coibentazione/Insulated

IT: Defangatore per Impianto Riscaldamento  
EN: Hydraulic mud remover for heating system  
FR: Séparateur de boeus pour chauffage

Art. CS 113C	Codice	Misura	Box	€
	CS113C003010	3" x 1"	1	399,85
	CS113C004012	4" x 1 1/4"	1	458,46
	CS113C004015	4" x 1 1/2"	1	502,32
	CS113C005020	5" x 2"	1	600,05
	CS113C006065	6" x dn65	1	942,03
	CS113C008080	8" x dn80	1	1436,16
	CS113C0010100	10" x dn100	1	1838,20



Con Coibentazione/Insulated

**VALVOLE MISCELATRICI E DEVIATRICI**  
**MIXING VALVES**  
**VANNES DE MELANGE**



IT: Valvola Miscelatrice Deviatrica a Farfalla tre vie Filettata  
EN: Butterfly mixing diverting three ways valve threaded pattern  
FR: Vanne papillon mélangeur inverseur trois voies fileté

**Art VZ 420**

Codice	Misura	Box	€
VZ0420000007	3/4"	1	121,80
VZ0420000010	1"	1	123,90
VZ0420000012	1 1/4"	1	137,55
VZ0420000015	1 1/2"	1	148,05
VZ0420000020	2"	1	169,05
VZ0420000025	2 1/2"	1	263,55



IT: Valvola Miscelatrice Deviatrica a Settore tre vie Filettata  
EN: Mixing diverting sector three ways valve threaded pattern  
FR: Vanne mélangeur inverseur trois voies à secteur fileté

**Art VZ 420S**

Codice	Misura	Box	€
VZ0420S00007	3/4"	1	132,30
VZ0420S00010	1"	1	134,40
VZ0420S00012	1 1/4"	1	137,55
VZ0420S00015	1 1/2"	1	149,10
VZ0420S00020	2"	1	180,60
VZ0420S00025	2 1/2"	1	262,50



IT: Valvola Miscelatrice Deviatrica a Farfalla tre vie Flangiata  
EN: Butterfly mixing diverting three ways valve flanged pattern  
FR: Vanne papillon mélangeur inverseur trois voies à bride

**Art. VZ 419**

Codice	Misura	Box	€
VZ0419000032	DN 32	1	191,10
VZ0419000040	DN 40	1	199,50
VZ0419000050	DN 50	1	260,40
VZ0419000065	DN 65	1	329,70
VZ0419000080	DN 80	1	415,80
VZ0419000100	DN 100	1	519,75
VZ0419000125	DN 125	1	884,10



IT: Valvola Miscelatrice Deviatrica a Settore a tre vie Flangiata  
EN: Mixing diverting sector three ways valve flanged pattern  
FR: Vanne mélangeur inverseur trois voies à secteur à bride

**Art VZ 419S**

Codice	Misura	Box	€
VZ0419S00032	DN 32	1	191,10
VZ0419S00040	DN 40	1	199,50
VZ0419S00050	DN 50	1	260,40
VZ0419S00065	DN 65	1	329,70
VZ0419S00080	DN 80	1	415,80
VZ0419S00100	DN 100	1	519,75
VZ0419S00125	DN 125	1	884,10



IT: Valvola Miscelatrice Deviatrica quattro vie Filettata  
EN: Mixing diverting four ways mixing valve threaded pattern  
FR: Vanne mélangeur inverseur quatre voies fileté

**Art. VZ 421**

Codice	Misura	Box	€
VZ0421000007	3/4"	1	132,30
VZ0421000010	1"	1	134,40
VZ0421000012	1 1/4"	1	137,55
VZ0421000015	1 1/2"	1	148,05
VZ0421000020	2"	1	180,60
VZ0421000025	2 1/2"	1	273,00



IT: Valvola Miscelatrice Deviatrica quattro vie Flangiata  
EN: Mixing diverting four ways valve flanged pattern  
FR: Vanne mélangeur inverseur quatre voies à bride

**Art VZ 424**

Codice	Misura	Box	€
VZ0424000032	DN 32	1	225,75
VZ0424000040	DN 40	1	242,55
VZ0424000050	DN 50	1	295,05
VZ0424000065	DN 65	1	372,75
VZ0424000080	DN 80	1	554,40
VZ0424000100	DN 100	1	623,70
VZ0424000125	DN 125	1	1161,30







🇮🇹 VZ - Valvole miscelatrici e deviatrici

🇬🇧 VZ - Mixing valves

🇫🇷 VZ - Vannes de melange

IT: Motore per Valvola Misc.Deviatrica ON/OFF 3punti corsa 90° 220sec c/micron

EN: Motor for diverting mixing valve ON/OFF 3points 90° 220sec w/micron

FR: Moteur pour vanne mélangeur inverseur 3points 90° 220sec avec micron

IT: Valvola miscelatrice Termostatica tre vie attacco bocchettone

EN: Three ways mixing valve with male 3 pieces connection

FR: Vanne mélangeur thermostatique avec douille

**Art VZ MVM**

**Codice**

**Misura**

**Box**

**€**

VZ0MVM100230  
 VZ0MVM100024

Dal 3/4"  
 A 2"

1  
 1

**262,50**  
**262,50**

VZ0MVM200230  
 VZ0MVM200024

Dal dn 65  
 A dn 125

1  
 1

**294,00**  
**294,00**



**Art VZ 156**

**Codice**

**Misura**

**Box**

**€**

VZ0156000007  
 VZ0156000010

3/4"  
 1"

1  
 1

**77,89**  
**82,26**

Solare termico

VZ0156X00010  
 VZ0156X00010

3/4"  
 1"

1  
 1

**81,00**  
**84,00**



VALVOLE CON ATTUATORE  
ACTUATOR VALVES  
VANNES MOTORIZEES

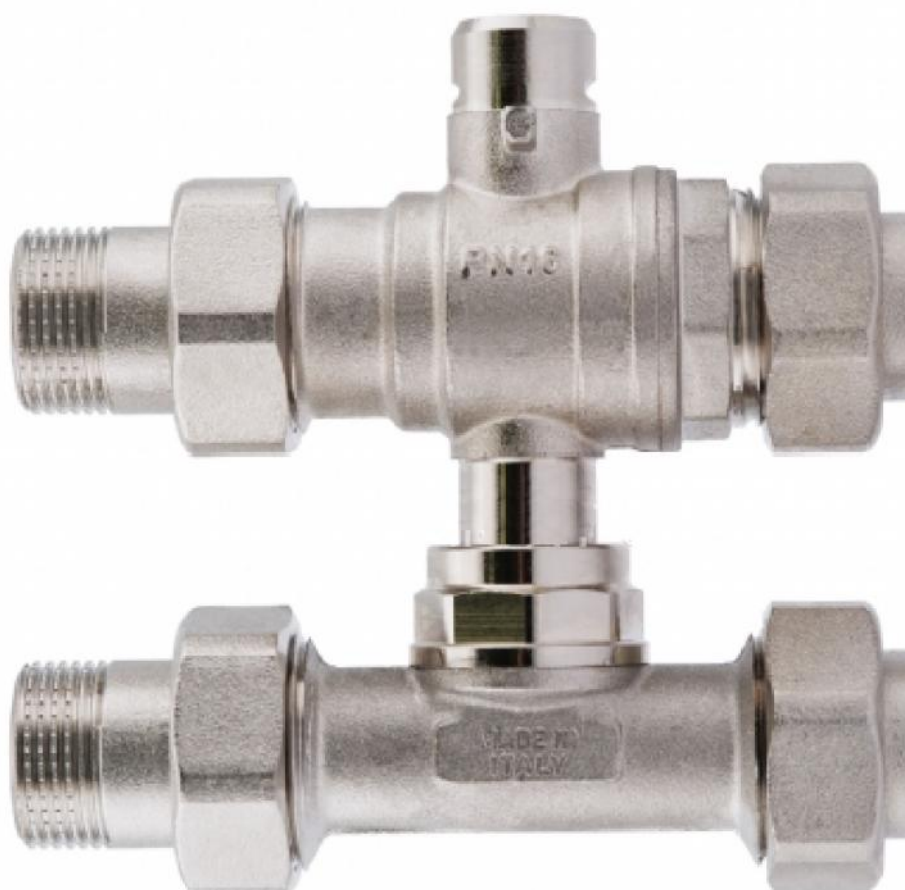

IT: Valvola sfera di Zona due vie motorizzata M/F c/bocchettone  
 EN: Two ways motorie valve m/f with nut and tail  
 FR: Vanne motorisée deux voies M/F avec douille

Art VZ 811	Codice	Misura	Box	€
	VZ0811000007	3/4"	1	24,06
	VZ0811000010	1"	1	33,18
	VZ0811000012	1"1/4	1	40,51



IT: Valvola sfera di Zona due vie Motorizzata c/bocchettone  
 EN: Two ways motorie valve with nut and tail  
 FR: Vanne motorisée deux voies avec douille

Art VZ 812	Codice	Misura	Box	€
	VZ0812000007	3/4"	1	28,87
	VZ0812000010	1"	1	41,71
	VZ0812000012	1"1/4	1	51,73



IT: Valvola sfera di Zona tre vie Motorizzata c/bocchettone  
 EN: Three ways motorie valve with nut and tail  
 FR: Vanne motorisée trois voies avec douille

Art. VZ 813	Codice	Misura	Box	€
	VZ0813000007	3/4"	1	39,42
	VZ0813000010	1"	1	58,75



IT: Valvola sfera di Zona quattro vie Motorizzata Miscelatrice c/ by pass  
 EN: Four ways motorie mixing valve with by pass  
 FR: Vanne motorisée quatre voies mélange avec by pass

Art VZ 814	Codice	Misura	Box	€
	VZ0814000007	3/4"	1	54,91
	VZ0814000010	1"	1	78,21



IT: Servocomando elettrico valvole di zona 230V o 24V  
 EN: Electric actuator for zone valves 230V or 24V  
 FR: Servocommande électrique pour vannes de zone 230V ou 24V

Art. VZ 215	Codice	Misura	Box	€
	VZ0215000230	230v	1	132,30
	VZ021500024	24v	1	132,30



IT: Servocomando elettrico valvole di zona 230V (solo per Art. 811 e 812)  
 EN: Electric actuator for zone valves 230V (only for Art. 811 and 812)  
 FR: Moteur électrique pour vannes de zone 230V (seulement pour Art. 811 et 812)

Art VZ 214	Codice	Misura	Box	€
	VZ0214000230	230v	1	99,00



**VZ - Valvole con attuatore**

**VZ - Actuator Valves**

**VZ - Vannes Motorizees**

IT: Valvola di zona F/F due vie Motorizzate ritorno a molla con micro ausiliario  
EN: Two Ways FE/FE motor valve with spring return an auxiliary switch  
FR: Vanne motorisée FE/FE deux voies ressort de rappel et commutateur auxiliaire

**Art VZM 812F**

Codice	Misura	Box	€
VZM812F00005	1/2"	1	155,93
VZM812F00007	3/4"	1	155,93
VZM812F00010	1"	1	155,93



IT: Valvola di zona F/F/F tre vie Motorizzate ritorno a molla con micro ausiliario  
EN: Three ways FE/FE/FE motorized valve with spring return and auxiliary switch  
FR: Vanne motorisée FE/FE/FE trois voies ressort de rappel et commutateur auxiliaire

**Art VZM 813F**

Codice	Misura	Box	€
VZM813F00005	1/2"	1	159,13
VZM813F00007	3/4"	1	159,13
VZM813F00010	1"	1	159,13



IT: Valvola tre vie ad attuttore Filettata Motorizzata DN/OFF albero acciaio inox  
EN: Three ways shut-off motorized valve DN/OFF threaded with Stainless steel stem  
FR: Vanne motorisée DN/OFF trois voies filetée à siège avec barre en acier inoxydable

**Art VZM 422**

Codice	Misura	Box	€
VZM422000005	1/2"	1	160,65
VZM422000007	3/4"	1	161,70
VZM422000010	1"	1	173,25
VZM422000012	1"1/4	1	187,95
VZM422000015	1"1/2	1	208,95
VZM422000020	2"	1	349,65



Il prezzo s'intende per la sola valvola senza il motore

IT: Valvola tre vie ad attuttore Flangiata Motorizzato DN/OFF albero acciaio inox  
EN: Three ways shut-off motorized valve flanged DN/OFF with Stainless steel stem  
FR: Vanne motorisée DN/OFF trois voies à bride avec barre en acier inoxydable

**Art VZM 425**

Codice	Misura	Box	€
VZM425000050	DN 50	1	651,53
VZM425000065	DN 65	1	874,65
VZM425000080	DN 80	1	1067,43
VZM425000100	DN 100	1	1963,50
VZM425000125	DN 125	1	3373,65
VZM425000150	DN 150	1	3927,00



Il prezzo s'intende per la sola valvola senza il motore

IT: Motore per Valvola tre vie Filettata DN/OFF tre punti  
EN: Motor for three way motorized valve threaded pattern DN/OFF three points  
FR: Moteur pour vanne motorisée filetée trois voies DN/OFF trois point

**Art VZM 423**

Codice	Misura	Box	€
VZM423000230	230V	1	313,00
VZM42300024	24V	1	313,00



Carico max 25kg tempo di corsa 75seconds

IT: Motore per Valvola tre vie Flangiata DN/OFF tre punti  
EN: Motor for three ways motorized valve flanged pattern DN/OFF three points  
FR: Moteur pur vanne motorisée à bride trois voies DN/OFF trois points

**Art VZM 426**

Codice	Misura	Box	€
VZM426000230	230V	1	560,00
VZM42600024	24V	1	560,00



Carico max 140kg tempo di corsa 150 secondi

VALVOLE INDUSTRIALI  
INDUSTRIAL VALVES  
ROBINETTERIE INDUSTRIELLE



IT: Valvola a farfalla WAFER PN 16  
EN: Butterfly valve WAFER pattern PN 16  
FR: Vanne papillon WAFER PN 16

**Art VI 235T**



Codice	Misura	Box	€
VIO235T04000	DN 40	1	41,27
VIO235T05000	DN 50	1	45,20
VIO235T06500	DN 65	1	55,83
VIO235T08000	DN 80	1	61,15
VIO235T10000	DN 100	1	82,42
VIO235T12500	DN 125	1	109,73
VIO235T15000	DN 150	1	126,45
VIO235T20000	DN 200	1	197,47
VIO235T25000	DN 250	1	476,18
VIO235T30000	DN 300	1	526,44

IT: Valvola a farfalla LUG PN 16  
EN: Butterfly valve LUG pattern PN 16  
FR: Vanne papillon LUG PN 16

**Art VI 255T**



Codice	Misura	Box	€
VIO255T04000	DN 40	1	51,90
VIO255T05000	DN 50	1	61,15
VIO255T06500	DN 65	1	69,13
VIO255T08000	DN 80	1	75,83
VIO255T10000	DN 100	1	116,99
VIO255T12500	DN 125	1	138,12
VIO255T15000	DN 150	1	157,42
VIO255T20000	DN 200	1	389,67
VIO255T25000	DN 250	1	709,67
VIO255T30000	DN 300	1	1058,05

IT: Valvola a farfalla WAFER PN 16 (asta lente inox)  
EN: Butterfly valve WAFER PN 16 (stainless steel stem/lens)  
FR: Vanne papillon WAFER PN 16 (barre / disque en acier inoxydable)

**Art VIK 235T**



Codice	Misura	Box	€
VIK235T04000	DN 40	1	54,56
VIK235T05000	DN 50	1	57,22
VIK235T06500	DN 65	1	71,79
VIK235T08000	DN 80	1	83,81
VIK235T10000	DN 100	1	116,99
VIK235T12500	DN 125	1	161,34
VIK235T15000	DN 150	1	207,79
VIK235T20000	DN 200	1	340,64
VIK235T25000	DN 250	1	647,73
VIK235T30000	DN 300	1	934,18

IT: Valvola a farfalla LUG PN 16 (asta lente inox)  
EN: Butterfly valve LUG PN 16 (stainless steel stem/lens)  
FR: Vanne papillon LUG PN 16 (barre / disque en acier inoxydable)

**Art VIK 255T**



Codice	Misura	Box	€
VIK255T04000	DN 40	1	58,49
VIK255T05000	DN 50	1	63,81
VIK255T06500	DN 65	1	75,83
VIK255T08000	DN 80	1	93,06
VIK255T10000	DN 100	1	148,89
VIK255T12500	DN 125	1	193,55
VIK255T15000	DN 150	1	241,23
VIK255T20000	DN 200	1	467,80
VIK255T25000	DN 250	1	851,40
VIK255T30000	DN 300	1	1270,00

IT: Valvola a farfalla LUG per gas  
EN: Butterfly valve LUG pattern gaz  
FR: Vanne papillon LUG pour gaz

**Art VI 355T**



Codice	Misura	Box	€
VIO355T04000	DN 40	1	127,00
VIO355T05000	DN 50	1	128,00
VIO355T06500	DN 65	1	144,00
VIO355T08000	DN 80	1	165,00
VIO355T10000	DN 100	1	189,00
VIO355T12500	DN 125	1	224,00
VIO355T15000	DN 150	1	243,00
VIO355T20000	DN 200	1	387,00

IT: Saracinesca in ghisa a Cuneo Gommato PN 16  
EN: Soft sealed gate valve PN 16  
FR: Vanne à opercule caoutchouc PN 16

**Art VI 44**



Codice	Misura	Box	€
VIO044004000	DN 40	1	121,00
VIO044005000	DN 50	1	143,00
VIO044006500	DN 65	1	177,00
VIO044008000	DN 80	1	205,00
VIO044100000	DN 100	1	242,00
VIO044125000	DN 125	1	385,00
VIO044150000	DN 150	1	420,00
VIO044200000	DN 200	1	716,00
VIO044225000	DN 250	1	1125,00
VIO044230000	DN 300	1	1570,00

IT: Valvola a Globo Flusso Avviato di Arresto PN 16  
EN: Globe valve flanged type PN 16  
FR: Robinet soupape à soufflet fonte PN 16

**Art VI 43**



Codice	Misura	Box	€
VI0043002000	DN 20	1	66,00
VI0043002500	DN 25	1	78,40
VI0043003200	DN 32	1	95,20
VI0043004000	DN 40	1	125,60
VI0043005000	DN 50	1	154,00
VI0043006500	DN 65	1	203,80
VI0043008000	DN 80	1	292,30
VI0043010000	DN 100	1	376,30
VI0043012500	DN 125	1	622,00
VI0043015000	DN 150	1	846,70

IT: Valvola a farfalla bi-flangiata doppio eccentrico PN 16  
EN: Double flanged butterfly valve double eccentric PN 16  
FR: Vanne papillon deux brides double eccentric PN 16

**Art VI 256T**



Codice	Misura	Box	€
VI0256T15000	DN 150	1	1755,00
VI0256T20000	DN 200	1	2082,00
VI0256T25000	DN 250	1	2861,00
VI0256T30000	DN 300	1	3159,00
VI0256T35000	DN 350	1	3873,00
VI0256T40000	DN 400	1	5349,00
VI0256T45000	DN 450	1	6211,00
VI0256T50000	DN 500	1	8871,00
VI0256T60000	DN 600	1	11846,00

IT: Valvola di Ritengo a Doppio Battente PN 16  
EN: Dual plate check valve PN 16  
FR: Clapet à disc double battant entre bride PN 16

**Art VI 122**



Codice	Misura	Box	€
VI0122004000	DN 40	1	44,70
VI0122005000	DN 50	1	55,60
VI0122006500	DN 65	1	65,70
VI0122008000	DN 80	1	85,90
VI0122010000	DN 100	1	106,10
VI0122012500	DN 125	1	143,80
VI0122015000	DN 150	1	211,30
VI0122020000	DN 200	1	349,80
VI0122025000	DN 250	1	505,40
VI0122030000	DN 300	1	682,90

IT: Valvola di Ritengo a Palla Flangiata PN 16  
EN: Ball check valve flanged type PN 16  
FR: Clapet à boule à bride PN 16

**Art VI 69F**



Codice	Misura	Box	€
VI0069F05000	DN 50	1	156,87
VI0069F06500	DN 65	1	198,14
VI0069F08000	DN 80	1	246,66
VI0069F10000	DN 100	1	316,40
VI0069F12500	DN 125	1	451,61
VI0069F15000	DN 150	1	600,05
VI0069F20000	DN 200	1	1292,88
VI0069F25000	DN 250	1	2207,76
VI0069F30000	DN 300	1	2996,08

IT: Valvola di ritengo a Clapet Flangiata PN 16  
EN: Flanged swing check valve PN 16  
FR: Clapet anti-retour à bride PN 16

**Art VI 71**



Codice	Misura	Box	€
VI0071005000	DN 50	1	113,06
VI0071006500	DN 65	1	172,82
VI0071008000	DN 80	1	218,02
VI0071010000	DN 100	1	263,22
VI0071012500	DN 125	1	394,83
VI0071015000	DN 150	1	567,73
VI0071020000	DN 200	1	756,12
VI0071025000	DN 250	1	1229,71
VI0071030000	DN 300	1	1738,09

IT: Valvola Ritengo a Palla Filettata PN 16  
EN: Ball check valve threaded type PN 16  
FR: Clapet à boule filetée PN 16

**Art VI 69**



Codice	Misura	Box	€
VI0069001000	1"	1	67,86
VI0069001200	1 1/4"	1	69,13
VI0069001500	1 1/2"	1	83,81
VI0069002000	2"	1	99,76
VI0069002500	2 1/2"	1	146,23
VI0069003000	3"	1	198,14

IT: Valvola di bilanciamento  
EN: Balancing valve  
FR: Robinet d'équilibrage

**Art VI 200**



Codice	Misura	Box	€
V10200000150	1/2"	1	81,00
V10200000200	3/4"	1	87,00
V10200000250	1"	1	100,50
V10200000320	1 1/4"	1	121,00
V10200000400	1 1/2"	1	149,50
V10200000500	2"	1	210,00
V10200000650	DN 65	1	414,00
V10200000800	DN 80	1	663,00
V10200010000	DN 100	1	990,00

Altre misure a richiesta

IT: Sfiato automatico doppio Galleggiante a tre funzioni PN 16  
EN: Double chambre three functions air release valve PN 16  
FR: Air purgeur automatique double flotteur trois fonctions PN 16

**Art VI 60**



Codice	Misura	Box	€
V10102050000	DN 50	1	406,98
V10102065000	DN 65	1	419,70
V10102080000	DN 80	1	425,70
V10102100000	DN 100	1	554,17
V10102125000	DN 125	1	584,46
V10102150000	DN 50	1	641,07
V10102120000	DN 200	1	1190,34

IT: Sfiato automatico semplice Galleggiante a due funzioni PN 16  
EN: Simple chambre two functions air release valve PN 16  
FR: Air purgeur automatique simple flotteur deux fonctions PN 16

**Art VI 100**



Codice	Misura	Box	€
V10100005000	DN 50	1	277,95
V10100006500	DN 65	1	288,49
V10100008000	DN 80	1	297,36
V10100010000	DN 100	1	452,20
V10100012500	DN 125	1	485,69
V10100015000	DN 150	1	566,61
V10100012000	DN 200	1	1077,80

IT: Filtro di Impurità ad Y in ghisa Flangiato PN 16  
EN: Flanged cast iron Y strainer PN 16  
FR: Filtre Y bride fonte PN 16

**Art VI 280**



Codice	Misura	Box	€
V10280004000	DN 40	1	59,77
V10280005000	DN 50	1	90,27
V10280006500	DN 65	1	130,19
V10280008000	DN 80	1	148,80
V10280010000	DN 100	1	193,99
V10280012500	DN 125	1	275,35
V10280015000	DN 150	1	384,18
V10280020000	DN 200	1	671,83
V10280025000	DN 250	1	1102,38
V10280030000	DN 300	1	1652,10

IT: Valvola a sfera flangiata in ghisa  
EN: Cast Iron flanged ball valve  
FR: Vanne à boisseau spherique en fonte

**Art. VI 10**



Codice	Misura	Box	€
V100100005000	DN 50	1	175,32
V100100006500	DN 65	1	248,40
V100100008000	DN 80	1	316,08
V100100010000	DN 100	1	425,04
V100100010000	DN 125	1	742,80
V100100010000	DN 150	1	969,96

IT: Disconnettore Controllabile  
EN: Controlled backflow  
FR: Disconnecteur controlable

**Art VI 110**



Codice	Misura	Box	€
V10110000005	1/2"	1	423,98
V10110000007	3/4"	1	486,28
V10110000010	1"	1	629,57
V10110000012	1 1/4"	1	841,40
V10110000015	1 1/2"	1	1296,53
V10110000020	2"	1	1440,15
V10110000065	DN 65	1	2636,35
V10110000080	DN 80	1	3093,56
V10110000100	DN 100	1	5256,89
V10110000150	DN 150	1	7284,60



IT: Giunto Antivibrante Compensatore Flangiato in Gomma  
EN: Flanged expansion joint  
FR: Compensateur élastomère à brides

**Art VI 10G**



Codice	Misura	Box	€
<u>VI0010G04000</u>	DN 40	1	<u>41,27</u>
<u>VI0010G05000</u>	DN 50	1	<u>49,25</u>
<u>VI0010G06500</u>	DN 65	1	<u>62,54</u>
<u>VI0010G08000</u>	DN 80	1	<u>74,45</u>
<u>VI0010G10000</u>	DN 100	1	<u>97,10</u>
<u>VI0010G12500</u>	DN 125	1	<u>125,22</u>
<u>VI0010G15000</u>	DN 150	1	<u>152,26</u>
<u>VI0010G20000</u>	DN 200	1	<u>227,09</u>
<u>VI0010G25000</u>	DN 250	1	<u>385,86</u>
<u>VI0010G30000</u>	DN 300	1	<u>507,14</u>

IT: Giunto Antivibrante Compensatore Filettato in Gomma  
EN: Threaded expansion joint  
FR: Compensateur élastomère taraudé gaz

**Art VI 30G**



Codice	Misura	Box	€
<u>VI0030G00700</u>	3/4"	1	<u>22,66</u>
<u>VI0030G01000</u>	1"	1	<u>30,63</u>
<u>VI0030G01200</u>	1 1/4"	1	<u>34,56</u>
<u>VI0030G01500</u>	1 1/2"	1	<u>43,93</u>
<u>VI0030G02000</u>	2"	1	<u>55,83</u>

IT: Compensatore Assiale Convogliatore flangiato per alte temperature  
EN: Stainless steel flanged expansion joint for high temperatures  
FR: Compensateur à brides en acier pour haute températures

**Art VI 10Y**



Codice	Misura	Box	€
<u>VI0010Y04000</u>	DN 40	1	<u>283,00</u>
<u>VI0010Y05000</u>	DN 50	1	<u>345,00</u>
<u>VI0010Y06500</u>	DN 65	1	<u>400,00</u>
<u>VI0010Y08000</u>	DN 80	1	<u>480,00</u>
<u>VI0010Y10000</u>	DN 100	1	<u>560,00</u>
<u>VI0010Y12500</u>	DN 125	1	<u>793,00</u>
<u>VI0010Y15000</u>	DN 150	1	<u>942,00</u>
<u>VI0010Y20000</u>	DN 200	1	<u>1230,00</u>

IT: Valvola di fondo in ghisa flangiata con filtro zincato  
EN: Silent check valve cast iron flanged pattern with filter  
FR: Vanne crepine fonte avec filtre

**Art VI 400FC**



Codice	Misura	Box	€
<u>VI0400FC0500</u>	DN 50	1	<u>132,88</u>
<u>VI0400FC0650</u>	DN 65	1	<u>192,19</u>
<u>VI0400FC0800</u>	DN 80	1	<u>226,04</u>
<u>VI0400FC1000</u>	DN 100	1	<u>295,36</u>
<u>VI0400FC1250</u>	DN 125	1	<u>395,61</u>
<u>VI0400FC1500</u>	DN 150	1	<u>533,29</u>
<u>VI0400FC2000</u>	DN 200	1	<u>812,34</u>
<u>VI0400FC2500</u>	DN 250	1	<u>1132,74</u>
<u>VI0400FC3000</u>	DN 300	1	<u>1779,87</u>

IT: Flangia Piana a saldare PN 16 EN 1092-1 DIN 2576  
 EN: Soldering Flat flange PN 16  
 FR: Bride plat à souder PN 16

Art VI 2278	Codice	Misura	Box	€
	VI2278002500	DN 25	1	
	VI2278003200	DN 32	1	
	VI2278004000	DN 40	1	
	VI2278005000	DN 50	1	
	VI2278006500	DN 65	1	
	VI2278008000	DN 80	1	
	VI2278010000	DN 100	1	
	VI2278012500	DN 125	1	
	VI2278015000	DN 150	1	
	VI2278020000	DN 200	1	

Prezzi netti a richiesta  
 Net prices on demand

IT: Flangia a Collare a saldare PN 16 EN 1092-1 DIN 2633  
 EN: Soldering Collar flange PN 16  
 FR: Bride avec collier à souder PN 16

Art VI 2282	Codice	Misura	Box	€
	VI02282002500	DN 25	1	
	VI02282003200	DN 32	1	
	VI02282004000	DN 40	1	
	VI02282005000	DN 50	1	
	VI02282006500	DN 65	1	
	VI02282008000	DN 80	1	
	VI02282010000	DN 100	1	
	VI02282012500	DN 125	1	
	VI02282015000	DN 150	1	
	VI02282020000	DN 200	1	

Prezzi netti a richiesta  
 Net prices on demand

IT: Flangia Filettata PN 16 EN 1092-1 DIN 2566  
 EN: Threaded flange PN 16  
 FR: Bride taraudè PN 16

Art VI 2290	Codice	Misura	Box	€
	VI2290002500	DN 25	1	
	VI2290003200	DN 32	1	
	VI2290004000	DN 40	1	
	VI2290005000	DN 50	1	
	VI2290006500	DN 65	1	
	VI2290008000	DN 80	1	
	VI2290010000	DN 100	1	
	VI2290012500	DN 125	1	
	VI2290015000	DN 150	1	
	VI2290020000	DN 200	1	

Prezzi netti a richiesta  
 Net prices on demand

IT: Flangia Cieca EN 1092-1 DIN 2527  
 EN: Blank flange  
 FR: Bride aveugle

Art VI 6093	Codice	Misura	Box	€
	VI6093002500	DN 25	1	
	VI6093003200	DN 32	1	
	VI6093004000	DN 40	1	
	VI6093005000	DN 50	1	
	VI6093006500	DN 65	1	
	VI6093008000	DN 80	1	
	VI6093010000	DN 100	1	
	VI6093012500	DN 125	1	
	VI6093015000	DN 150	1	
	VI6093020000	DN 200	1	

Prezzi netti a richiesta  
 Net prices on demand

IT: Guarnizione in fibra sintetica Esente Amianto per Flange  
 EN: O-ring in synthetic fibres free from amiant  
 FR: Fibre de joint sans amiante

Art GF	Codice	Misura	Box	€
	VI00GF000025	DN 25	10	0,71
	VI00GF000032	DN 32	10	0,92
	VI00GF000040	DN 40	10	1,11
	VI00GF000050	DN 50	10	1,51
	VI00GF000065	DN 65	10	2,11
	VI00GF000080	DN 80	10	2,58
	VI00GF000100	DN 100	10	3,81
	VI00GF000125	DN 125	5	4,91
	VI00GF000150	DN 150	5	6,76
	VI00GF000200	DN 200	1	10,12
	VI00GF000250	DN 250	1	15,53

IT: Vite più Dado per Flange  
 EN: Screw and nut for flange  
 FR: Boulonnerie pour bride

Art. VI Bullone + Dado				€
	VI00V0016035	16X35	50	0,72
	VI00V0016045	16X45	50	0,80
	VI00V0016050	16X50	50	0,84
	VI00V0016065	16X65	50	1,04
	VI00V0016070	16X70	50	1,10
	VI00V0016100	16X100	50	1,60
	VI00V0016110	16X110	50	2,43
	VI00V0020080	20X80	50	2,05
	VI00V0020120	20X120	50	4,14
	VI0000000016	16	50	0,18
	VI0000000020	20	50	0,32

PRODOTTI STAFFAGGIO  
ANCHORS AND FIXINGS  
SUPPORTAGE ET CHEVILLAGE



IT: Kit Collare Fermatubo Nudo pesante c/tassello  
EN: Kit Clamp and screw heavy pattern  
FR: Kit Collier avec cheville modèle lourd

**Art VI 386S**



Codice	Misura	Box	€
VIO386S00050	1/2	2	1,42
VIO386S00070	3/4	2	1,51
VIO386S00100	1"	2	1,58
VIO386S00120	1 1/4	2	1,64
VIO386S00150	1 1/2	2	1,95
VIO386S00200	2"	2	2,40
VIO386S00250	2 1/2	2	3,80
VIO386S00300	3"	2	4,10
VIO386S00400	4"	2	4,39

IT: Kit Collare Fermatubo Gommato pesante c/tassello  
EN: Kit Clamp and screw heavy pattern—EPDM  
FR: Kit Collier avec cheville modèle lourd—EPDM

**Art VI 386G**



Codice	Misura	Box	€
VIO386G00050	1/2	2	2,25
VIO386G00070	3/4	2	2,36
VIO386G00100	1"	2	2,54
VIO386G00120	1 1/4	2	2,87
VIO386G00150	1 1/2	2	3,11
VIO386G00200	2"	2	3,69
VIO386G00250	2 1/2	2	4,83
VIO386G00300	3"	2	5,21
VIO386G00400	4"	2	6,81

IT: Collare Fermatubo Nudo modello pesante  
EN: Heavy clamp naked pattern  
FR: Collier nu modèle lourd

**Art VI 388S**



Codice	Misura	Box	€
VIO388S00050	1/2	1	1,02
VIO388S00070	3/4	1	1,24
VIO388S00100	1"	1	1,32
VIO388S00120	1 1/4	1	1,41
VIO388S00150	1 1/2	1	1,49
VIO388S00200	2"	1	1,88
VIO388S00250	2 1/2	1	2,72
VIO388S00300	3"	1	3,03
VIO388S00400	4"	1	3,44

IT: Collare Fermatubo Gommato modello pesante  
EN: Heavy clamp EPDM pattern  
FR: Collier EPDM modèle lourd

**Art VI 388G**



Codice	Misura	Box	€
VIO388G00050	1/2	1	2,03
VIO388G00070	3/4	1	2,12
VIO388G00100	1"	1	2,29
VIO388G00120	1 1/4	1	2,87
VIO388G00150	1 1/2	1	2,80
VIO388G00200	2"	1	3,32
VIO388G00250	2 1/2	1	4,35
VIO388G00300	3"	1	4,69
VIO388G00400	4"	1	6,13

IT: Collare Fermatubo Nudo modello Export  
EN: Heavy clamp Export pattern  
FR: Collier nu modèle Export

**Art VI 386ST**



Codice	Misura	Box	€
VIO386ST0030	3/8	10	0,55
VIO386ST0050	1/2	10	0,58
VIO386ST0070	3/4	10	0,64
VIO386ST0100	1"	10	0,71
VIO386ST0120	1 1/4	10	0,82
VIO386ST0150	1 1/2	10	0,96
VIO386ST0200	2"	10	1,06
VIO386ST0250	2 1/2	5	1,86
VIO386ST0300	3"	5	2,17
VIO386ST0400	4"	5	2,65
VIO386ST0500	5"	1	3,76
VIO386ST0600	6"	1	4,36

IT: Collare Fermatubo Gommato modello Export  
EN: Clamp EPDM pattern Export  
FR: Collier EPDM modèle Export

**Art VI 386GT**



Codice	Misura	Box	€
VIO386GT0050	1/2	10	0,69
VIO386GT0070	3/4	10	0,77
VIO386GT0100	1"	10	0,85
VIO386GT0120	1 1/4	10	0,98
VIO386GT0150	1 1/2	10	1,14
VIO386GT0200	2"	10	1,25
VIO386GT0250	2 1/2	5	2,21
VIO386GT0300	3"	5	2,57
VIO386GT0400	4"	5	3,16
VIO386GT0400	5"	1	4,47
VIO386GT0400	6"	1	5,19

IT: Barra Fissaggio c/asola  
 EN: Galvanized angle fixing bar  
 FR: Rails acier zingué

**Art ST BARRA**

Codice	Misura	Box	€
STBARRA30X15	30x15 -2mt	1	6,80
STBARRA41X41	41x41 -3mt	1	18,00

Prezzo al metro



IT: Barra filettata in acciaio zincato l mt  
 EN: Galvanized stud screw l mt  
 FR: Tiges filetée acier galvanisé

**Art ST BARFIL**

Codice	Misura	Box	€
STBAR081000	M8x1mt	1	1,20
STBAR101000	M10x1mt	1	1,84

Prezzo al metro



IT: Kit Dado, rondella e vite testa a martello  
 EN: Anchor kit screw and nut for fixing bar  
 FR: Boulon de rails promonté

**Art ST KIT MRD**

Codice	Misura	Box	€
STKITMR00008 (M8 x barra 40)	M8	10	2,16
STKITMR000083 (M8 x barra 30)	M8	10	1,80
STKITMR00010 (M10 x barra 40)	M10	10	2,40
STKITMR000103 (M10 x barra 30)	M10	10	2,00



IT: Prolunga esagonale per barra filettata  
 EN: Exagonal steel spacer sleeve  
 FR: Ecrou exagonal pour tiges

**Art ST MANI**

Codice	Misura	Box	€
STMANI00008	M8	10	0,44
STMANI00010	M10	10	0,92



IT: Tassello Espansione ottone  
 EN: Wedge brass anchor W-ED  
 FR: Cheville à expansion en laiton W-ED

**Art ST TAS**

Codice	Misura	Box	€
STTASS000008	M8	10	0,84
STTASS000010	M10	10	1,24



IT: Dado zincato  
 EN: Galvanized Nut  
 FR: Ecrou Galvanisé

**Art VI DADO**

Codice	Misura	Box	€
VI000000008	M8	50	0,48
VI000000010	M10	50	0,52



VALVOLE TERMOSIFONE  
RADIATOR VALVES  
ROBINETS RADIATEUR



IT: Valvola Radiatore Termostattizzabile Squadra attacco Tubo Rame Multistrato  
 EN: Thermostatic radiator angle valve compression end for Copper / Multilayer pipe  
 FR: Robinet radiateur thermost. Equerre à compression pour tube Cuivre/Multicouche

**Art TH 105R**

Codice	Misura	Box	€
TH0105R0300N	3/8"	10	11,35
TH0105R0500N	1/2"	10	11,84



IT: Valvola Radiatore Termostattizzabile Diritta attacco Tubo Rame Multistrato  
 EN: Thermostatic radiator valve compression end for Copper and Multilayer pipe  
 FR: Robinet radiateur thermostattizable à compression pour tube Cuivre / Multicouche

**Art TH 106R**

Codice	Misura	Box	€
TH0106R0300N	3/8"	10	11,30
TH0106R0500N	1/2"	10	12,72



IT: Detentore a Squadra attacco Tubo Rame Multistrato  
 EN: Lockshied angle pattern compression end for Copper/Multilayer pipe  
 FR: Coude de réglage à compression pour tube Cuivre/Multicouche

**Art VT 117R**

Codice	Misura	Box	€
VTO117R0300N	3/8"	10	5,40
VTO117R0500N	1/2"	10	5,78



IT: Detentore Diritto attacco Tubo Rame Multistrato  
 EN: Lockshied compression end for Copper/Multilayer pipe  
 FR: Tè de réglage à compression pour tube Cuivre/Multicouche

**Art VT 118R**

Codice	Misura	Box	€
VTO118R0300N	3/8"	10	5,61
VTO118R0500N	1/2"	10	6,39



IT: Valvola Radiatore Termostattizzabile Squadra attacco Tubo Ferro  
 EN: Thermostatic radiator angle valve threaded pattern iron pipe connection  
 FR: Robinet radiateur thermostattizable èquerre avec lien pour tube fer

**Art TH 105**

Codice	Misura	Box	€
TH010500300N	3/8"	10	10,81
TH010500500N	1/2"	10	11,28



IT: Valvola Radiatore Termostattizzabile Diritta attacco Tubo Ferro  
 EN: Thermostatic radiator valve threaded pattern iron pipe connection  
 FR: Robinet radiateur thermostattizable avec lien pour tube fer

**Art TH 106**

Codice	Misura	Box	€
TH010600300N	3/8"	10	11,30
TH010600500N	1/2"	10	12,72



IT: Detentore a Squadra attacco Tubo Ferro  
 EN: Lockshield angle pattern iron pipe connection  
 FR: Coude de réglage pour tube fer

**Art VT 117**

Codice	Misura	Box	€
<u>VT011700300N</u>	<u>3/8"</u>	<u>10</u>	<u>5,50</u>
<u>VT011700500N</u>	<u>1/2"</u>	<u>10</u>	<u>6,31</u>
<u>VT011700700N</u>	<u>3/4"</u>	<u>10</u>	<u>11,72</u>



IT: Detentore Diritto attacco tubo Ferro  
 EN: Lockshield iron pipe connection  
 FR: Tè de réglage pour tube fer

**Art VT 118**

Codice	Misura	Box	€
<u>VT011800300N</u>	<u>3/8"</u>	<u>10</u>	<u>5,84</u>
<u>VT011800500N</u>	<u>1/2"</u>	<u>10</u>	<u>6,87</u>
<u>VT011800700N</u>	<u>3/4"</u>	<u>10</u>	<u>12,35</u>



IT: Valvola Radiatore Manuale Squadra attacco Tubo Rame Multistrato  
 EN: Manual radiator angle valve compression end for Copper /Multilayer pipe  
 FR: Robinet radiateur manuel èquerre à compression pour tube Cuivre / Multicouche

**Art VT 119R**

Codice	Misura	Box	€
<u>VT0119R0300N</u>	<u>3/8"</u>	<u>10</u>	<u>6,69</u>
<u>VT0119R0500N</u>	<u>1/2"</u>	<u>10</u>	<u>7,48</u>



IT: Valvola Radiatore Manuale Diritto attacco Tubo Rame Multistrato  
 EN: Manual radiator valve compression end for Copper /Multilayer pipe  
 FR: Robinet radiateur manuel à compression pour tube Cuivre /Multicouche

**Art VT 120R**

Codice	Misura	Box	€
<u>VT0120R0300N</u>	<u>3/8"</u>	<u>10</u>	<u>7,36</u>
<u>VT0120R0500N</u>	<u>1/2"</u>	<u>10</u>	<u>7,94</u>



IT: Detentore Squadra attacco Tubo Rame Multistrato  
 EN: Lockshield angle pattern compression end for Copper /Multilayer pipe  
 FR: Coude de réglage à compression pour tube Cuivre /Multicouche

**Art VT 117R**

Codice	Misura	Box	€
<u>VT0117R0300N</u>	<u>3/8"</u>	<u>10</u>	<u>5,40</u>
<u>VT0117R0500N</u>	<u>1/2"</u>	<u>10</u>	<u>5,78</u>



IT: Detentore Diritto attacco Tubo Rame Multistrato  
 EN: Lockshield compression end for Copper /Multilayer pipe  
 FR: Tè de réglage à compression pour tube Cuivre /Multicouche

**Art VT 118R**

Codice	Misura	Box	€
<u>VT0118R300N</u>	<u>3/8"</u>	<u>10</u>	<u>5,61</u>
<u>VT0118R500N</u>	<u>1/2"</u>	<u>10</u>	<u>6,39</u>





IT: Valvola Radiatore Manuale Squadra attacco Tubo Ferro  
 EN: Manual radiator angle valve threaded pattern iron pipe connection  
 FR: Robinet radiateur manuel équerre avec lien pour tube fer

**Art VT 119**

Codice	Misura	Box	€
<u>VT011900300N</u>	<u>3/8"</u>	<u>10</u>	<u>6,69</u>
<u>VT011900500N</u>	<u>1/2"</u>	<u>10</u>	<u>7,48</u>
<u>VT011900700N</u>	<u>3/4"</u>	<u>10</u>	<u>13,85</u>



IT: Valvola Radiatore Manuale Diritta attacco Tubo Ferro  
 EN: Manual radiator valve threaded pattern iron pipe connection  
 FR: Robinet radiateur manuel avec lien pour tube fer

**Art VT 120**

Codice	Misura	Box	€
<u>VT012000300N</u>	<u>3/8"</u>	<u>10</u>	<u>7,36</u>
<u>VT012000500N</u>	<u>1/2"</u>	<u>10</u>	<u>7,94</u>
<u>VT012000700N</u>	<u>3/4"</u>	<u>10</u>	<u>14,56</u>



IT: Detentore a Squadra attacco Tubo Ferro  
 EN: Lockshield angle pattern iron pipe connection  
 FR: Coude de réglage pour tube fer

**Art VT 117**

Codice	Misura	Box	€
<u>VT011700300N</u>	<u>3/8"</u>	<u>10</u>	<u>5,50</u>
<u>VT011700500N</u>	<u>1/2"</u>	<u>10</u>	<u>6,31</u>
<u>VT011700700N</u>	<u>3/4"</u>	<u>10</u>	<u>11,72</u>



IT: Detentore Diritto attacco Tubo Ferro  
 EN: Lockshield iron pipe connection  
 FR: Tè de réglage pour tube fer

**Art VT 118**

Codice	Misura	Box	€
<u>VT011800300N</u>	<u>3/8"</u>	<u>10</u>	<u>5,84</u>
<u>VT011800500N</u>	<u>1/2"</u>	<u>10</u>	<u>6,87</u>
<u>VT011800700N</u>	<u>3/4"</u>	<u>10</u>	<u>12,35</u>



IT: Valvola Radiatore Monotubo Manuale quattro vie  
 EN: Four ways monotube valve  
 FR: Robinet monotube quatre voies

**Art MT 201**

Codice	Misura	Box	€
<u>MT020100500N</u>	<u>1/2"</u>	<u>10</u>	<u>19,50</u>
<u>MT020100700N</u>	<u>3/4"</u>	<u>10</u>	<u>19,85</u>



IT: Valvola Radiatore Monotubo Termostattizzabile by-pass  
 EN: Thermostatic monotube valve with by-pass  
 FR: Robinet monotube thermostatizable avec by-pass

**Art MT 202**

Codice	Misura	Box	€
<u>MT020200500N</u>	<u>1/2"</u>	<u>10</u>	<u>24,18</u>





IT: Valvola H Doppia Diritta tenuta piatta  
 EN: Straight H double valve  
 FR: Robinet H double droite

**Art MT 90**

Codice	Misura	Box	€
MT009000700N	3/4"	10	14,85



IT: Valvola H Doppia a Squadra tenuta piatta  
 EN: Angle H double valve  
 FR: Robinet H équerre double

**Art MT 91**

Codice	Misura	Box	€
MT009100700N	3/4"	10	15,85



IT: Valvola Due vie per Fan Coil  
 EN: Two ways valve for Fan Coil  
 FR: Robinet deux voies pour Fan Coil

**Art MT 222**

Codice	Misura	Box	€
MT022200500N	1/2"	10	17,50
MT022200700N	3/4"	10	19,50
MT022201000N	1"	10	24,00



IT: Valvola Tre vie per Fan Coil  
 EN: Three ways fan coil valve  
 FR: Robinet trois voies pour fan coil

**Art MT 223**

Codice	Misura	Box	€
MT022300500N	1/2"	10	29,59
MT022300700N	3/4"	10	29,94
MT022301000N	1"	10	33,48



IT: Testa termoelettrica c/micron-switch Fan Coil  
 EN: Thermoelectric head w/micron-switch fan coil  
 FR: Tête thermoélectrique avec micron-switch fan coil

**Art TH 507**

Codice	Misura	Box	€
TH0507000230	230 volt	1	42,50
TH050700024	24 volt	1	42,50



IT: Valvola Quattro vie per Fan Coil  
 EN: Four ways fan coil valve  
 FR: Robinet quatre voies pour fan coil

**Art MT 224**

Codice	Misura	Box	€
MT022400500N	1/2"	10	36,76
MT022400700N	3/4"	10	37,35
MT022401000N	1"	10	43,51



ACCESSORI PER VALVOLE TERMOSIFONE  
ACCESSORIES FOR RADIATOR VALVES  
ACCESSOIRES POUR ROBINETS RADIATEUR



IT: Testa Termostatica con sensore a Liquido  
 EN: Thermostatic head with liquid sensor  
 FR: Tête thermostatique avec capteur liquide

**Art TH 108L**

Codice	Misura	Box	€
TH0108L00000		10	16,00



IT: Volantino Micrometrico per Valvola Termostatica  
 EN: Microtermic wheelhandle for thermostatic valve  
 FR: Volant microthermique pour robinet thermostatizable

**Art VOL3**

Codice	Misura	Box	€
VOL030000000		10	2,70



IT: Adattatore per Tubo Rame  
 EN: Copper pipe adapter  
 FR: Adaptateur pour tube Cuivre

**Art DC 240**

Codice	Misura	Box	€
DC024000310N	3/8" x10	10	1,64
DC024000312N	3/8" x12	10	1,64
DC024000512N	1/2" x12	10	1,64
DC024000514N	1/2" x14	10	1,64
DC024000515N	1/2" x15	10	1,64
DC024000516N	1/2" x16	10	1,64



IT: Adattatore per Tubo Multistrato  
 EN: Multilayer pipe adapter  
 FR: Adaptateur pour tube multicouche

**Art DC 283**

Codice	Misura	Box	€
DC0283000516	1/2" x16	10	2,34
DC0283000716	3/4" x16	10	2,79
DC0283000720	3/4" x20	10	2,79



IT: Sonda per Valvola Mono/Bitubo  
 EN: Probe for monotube/bitube valve  
 FR: Sonde pour robinet monotube/bitube

**Art DC 254**

Codice	Misura	Box	€
DC0254015060	∅15 600	1	1,24
DC0254015110	∅15 1100	1	1,56



IT: Raccordi con Or per Valvole H Art. 90/91  
 EN: H valve Or adapter for item 90/91  
 FR: Adaptateur pour robinet H avec OR pour Art. 90/91

**Art DC 300**

Codice	Misura	Box	€
DC0300000705	3/4" x1/2"	10	1,65



ACCESSORI PER RADIATORI  
ACCESSORIES FOR PANEL RADIATORS  
ACCESSOIRES FOR RADIATEURS



IT: Valvolina Sfogo Aria Manuale con o-ring  
EN: Manual discharge valve  
FR: Robinet de puisage

**Art PR 112**

Codice	Misura	Box	€
PRO112002000	1/4"	10	1,55
PRO112003000	3/8"	10	2,85
PRO112005000	1/2"	10	2,25



IT: Valvola Sfogo Aria con Scarico  
EN: Discharge valve with drain  
FR: Robinet de puisage avec purgeur

**Art PR 113**

Codice	Misura	Box	€
PRO113002000	1/4"	10	3,50
PRO113003000	3/8"	10	4,00



IT: Tappo per Radiatore Alluminio DX o SX  
EN: Aluminium radiator plug DX o SX  
FR: Bouchon pour radiateurs en aluminium DX o SX

**Art PR 286**

Codice	Misura	Box	€
PRO028600100	1"	10	1,40



IT: Tappo con Riduzione DX o SX  
EN: Plug with reduction DX SX  
FR: Bouchon avec reductio DX SX

**Art PR 287**

Codice	Misura	Box	€
PRO287001010	1"X1/8"	10	1,46
PRO287001020	1"X1/4"	10	1,46
PRO287001030	1"X 3/8"	10	1,46
PRO287001050	1"X 1/2"	10	1,46
PRO287001070	1"X 3/4"	10	2,75



IT: Mensola a Tassello per Radiatore in Alluminio  
EN: Anchor bracket for aluminium radiators  
FR: Pièce à bloquer pour radiateurs en aluminium

**Art 288C**

Codice	Misura	Box	€
PRO288C00195	195mm	10	4,20



IT: Mensola per Radiatore in Alluminio  
EN: Aluminium radiator bracket  
FR: Pièce pour radiateur en aluminium

**Art PR 298C**

Codice	Misura	Box	€
PRO298C00200	200mm	10	1,39



IT: Distanziatore Eccentrico per Radiatori Nikelato  
EN: Eccentric spacer for radiator nickel plated  
FR: Ecarteur excentrique pour radiateur nickelé

**Art PR 120**

Codice	Misura	Box	€
PRO120050100	1/2" - 100	50	7,00
PRO120050200	1/2" - 200	50	6,50
PRO120050300	1/2" - 300	50	7,00
PRO120050400	1/2" - 400	50	7,50
PRO120050500	1/2" - 500	50	8,00
PRO120050600	1/2" - 600	50	8,50



IT: Rosetta per Finitura  
EN: Covering flanges  
FR: Rosette applique

**Art PR 317C**

Codice	Misura	Box	€
PRO317C00010	Ø 10	10	0,37
PRO317C00012	Ø 12	10	0,37
PRO317C00014	Ø 14	10	0,37
PRO317C00016	Ø 16	10	0,37
PRO317C00018	Ø 18	10	0,37



COLLETTORI DI DISTRIBUZIONE  
MANIFOLDS  
COLLECTEURS



IT: Collettore di Distribuzione con Valvola di Chiusura due vie calda  
 EN: Modular distribution manifold two ways  
 FR: Collecteur de distribution deux voies

**Art CLR 982R**

Codice	Misura	Box	€
CLR982R0705N	3/4" x 1/2"	10	15,34
CLR982R1007N	1" x 3/4"	10	19,43



IT: Collettore di Distribuzione con Valvola di Chiusura due vie fredda  
 EN: Modular distribution manifold two ways  
 FR: Collecteur de distribution deux voies

**Art CLB 982R**

Codice	Misura	Box	€
CLB982R0705N	3/4" X 1/2"	10	15,34
CLB982R1007N	1" X 3/4"	10	19,43



IT: Collettore di Distribuzione con Valvola di Chiusura Tre vie calda  
 EN: Modular distribution manifold three ways  
 FR: Collecteur de distribution trois voies

**Art CLR 983R**

Codice	Misura	Box	€
CLR983R0705N	3/4" X 1/2"	10	21,54
CLR983R1007N	1" X 3/4"	10	27,24



IT: Collettore di Distribuzione con Valvola di Chiusura Tre vie fredda  
 EN: Modular distribution manifold three ways  
 FR: Collecteur de distribution trois voies

**Art CLB 983R**

Codice	Misura	Box	€
CLB983R0705N	3/4" X 1/2"	10	21,54
CLB983R1007N	1" X 3/4"	10	27,24



IT: Collettore di Distribuzione con Valvola di Chiusura quattro vie calda  
 EN: Modular distribution manifold four ways  
 FR: Collecteur de distribution quatre voies

**Art CLR 984R**

Codice	Misura	Box	€
CLR984R0705N	3/4" X 1/2"	10	29,72
CLR984R1007N	1" X 3/4"	10	38,03



IT: Collettore di Distribuzione con Valvola di Chiusura quattro vie fredda  
 EN: Modular distribution manifold four ways  
 FR: Collecteur de distribution quatre voies

**Art CLB 984R**

Codice	Misura	Box	€
CLB984R0705N	3/4" X 1/2"	10	29,72
CLB984R1007N	1" X 3/4"	10	38,03





IT: Collettore per Riscaldamento 2 vie  
 EN: Heating distribution manifold 2 ways  
 FR: Collecteur de distribution pour chauffage 2 voies

**Art CL 982M**

Codice	Misura	Box	€
CL0982M07050	3/4" X 1/2"	10	7,20
CL0982M01005	1" X 1/2"	10	9,20
CL0982M01007	1" X 3/4"	10	12,05



IT: Collettore per Riscaldamento 3 vie  
 EN: Heating distribution manifold 3 ways  
 FR: Collecteur de distribution pour chauffage 3 voies

**Art CL 983M**

Codice	Misura	Box	€
CL0983M07050	3/4" X 1/2"	10	9,93
CL0983M01005	1" X 1/2"	10	12,53
CL0983M01007	1" X 3/4"	10	17,12



IT: Collettore per Riscaldamento 4 vie  
 EN: Heating distribution manifold 4 ways  
 FR: Collecteur de distribution pour chauffage 4 voies

**Art CL 984M**

Codice	Misura	Box	€
CL0984M07050	3/4" X 1/2"	10	12,76
CL0984M01005	1" X 1/2"	10	15,68
CL0984M01007	1" X 3/4"	10	23,63



IT: Collettore per Riscaldamento 5 vie  
 EN: Heating distribution manifold 5 ways  
 FR: Collecteur de distribution pour chauffage 5 voies

**Art CL 985M**

Codice	Misura	Box	€
CL0985M07050	3/4" X 1/2"	10	16,33
CL0985M01005	1" X 1/2"	10	19,44



IT: Collettore Femmina da barra per Riscaldamento 3/4" x 1/2" interasse 50mm  
 EN: Bar Female manifold for heating 3/4" x 1/2"  
 FR: Collecteur bar femelle pour chauffage 3/4" x 1/2"

**Art CL 985F**

Codice	Misura	Box	€
CL985F070502	2 vie	10	9,68
CL985F070503	3 vie	10	14,14
CL985F070504	4 vie	10	19,14
CL985F070505	5 vie	10	24,85
CL985F070506	6 vie	10	28,13
CL985F070507	7 vie	10	33,83
CL985F070508	8 vie	10	38,03
CL985F070509	9 vie	10	41,90
CL985F070510	10 vie	10	46,31



IT: Collettore Complanare attacchi 1/2"  
 EN: Modular complanar manifold  
 FR: Collecteur bilatérale

**Art CLG 985**

Codice	Misura	Box	€
CLG985000704	3/4" X 4	1	56,48
CLG985000706	3/4" X 6	1	80,08
CLG985000708	3/4" X 8	1	103,62
CLG985001004	1" X 4	1	63,17
CLG985001006	1" X 6	1	89,17
CLG985001008	1" X 8	1	116,18



IT: Adattatore per Tubo Rame  
 EN: Copper pipe adapter  
 FR: Adaptateur pour tube cuivre

Art DC 240	Codice	Misura	Box	€
	DC024000310N	3/8" X 10	10	1,64
	DC024000312N	3/8" X 12	10	1,64
	DC024000512N	1/2" X 12	10	1,64
	DC024000514N	1/2" X 14	10	1,64
	DC024000515N	1/2" X 15	10	1,64
	DC024000516N	1/2" X 16	10	1,64

IT: Adattatore per Tubo Multistrato (valvola manuale - termostatica - collettori)  
 EN: Multilayer pipe adapter (for manifolds thermostatic manual valve)  
 FR: Adaptateur pour tube multicouche (pour robinet thermost.manuel pour collecteurs)

Art DC 283	Codice	Misura	Box	€
	DC0283000516	1/2" X 16	10	2,34
	DC0283000716	3/4" X 16	10	2,79
	DC0283000720	3/4" X 20	10	2,79

IT: Adattatore Eurocono per Tubo PEX  
 EN: PEX pipe adapter Eurokonus  
 FR: Adaptateur pour tube PEX Eurokonus

Art DC 83P	Codice	Misura	Box	€
	DC0083P00716	3/4" X 16	10	3,27
	DC0083P00720	3/4" X 20	10	3,27

IT: Adattatore Eurocono per Tubo Multistrato  
 EN: Multilayer pipe adapter Eurokonus  
 FR: Adaptateur pour tube multicouche Eurokonus

Art DC 83M	Codice	Misura	Box	€
	DC0083M00716	3/4" X 16	10	3,22
	DC0083M00720	3/4" X 20	10	3,22

IT: Cassetta in Plastica per Collettori  
 EN: Plastic box for manifolds  
 FR: Armoire en PVC pour collecteur

Art CS 32	Codice	Misura	Box	€
	CS3200000320	320 X 280	1	26,09
	CS3200000420	420 X 300	1	28,71
	CS3200000520	520 X 320	1	30,91
	CS3200000600	600 X 310	1	49,00

Profondità  
80  
mm

IT: Cassetta in Lamiera per Collettori  
 EN: Iron box for manifolds  
 FR: Armoire en feuille pour collecteurs

Art CS 35	Codice	Misura	Box	€
	CS0350000400	Fino a 3 vie	1	105,00
	CS0350000600	Fino a 7 vie	1	141,00
	CS0350000800	Fino a 11 vie	1	182,00
	CS0350001000	Fino a 13 vie	1	237,00

Profondità  
80-120  
mm

**PRODOTTI RISCALDAMENTO RADIANTE**  
**HEATING FLOOR PRODUCTS**  
**PRODUITS CHAUFFAGE AU SOL**

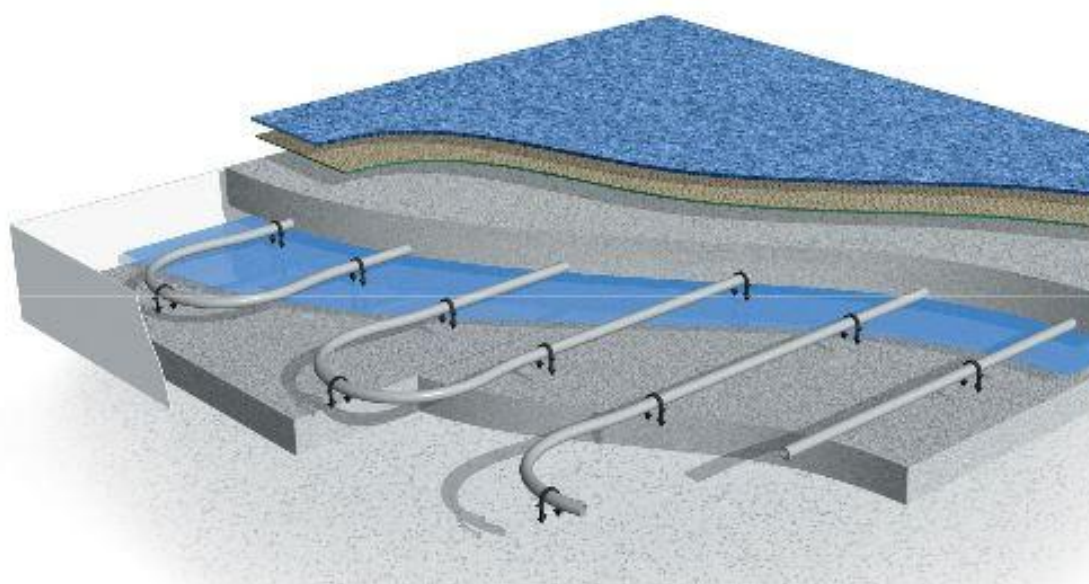

**Sistemi di riscaldamento e raffrescamento radiante**

**Agi-comfort<sup>®</sup>**

[www.agicomfort.it](http://www.agicomfort.it)

**Assotherm**  
Servizi associati per la termoidraulica

IT: Pannello Bugnato in Polistirolo Espanso  
 EN: Insulation panel for heating floor  
 FR: Panneau d'isolation pour chauffage au sol

**Art AGIPLAN**

Codice	Misura	Box	€
AGIPLAN00030	10+20mm	10	15,50
AGIPLAN00040	20+20mm	7,5	18,00
AGIPLAN00050	30+20mm	6	22,00



IT: Pannello in Doghe di Polistirene Estruso XPS  
 EN: Insulation Roll for heating floor  
 FR: Roll d'isolation en polystyrene pour chauffage au sol

**Art AGIROLL**

Codice	Misura	Box	€
AGIROLL00020	20mm	15	15,00
AGIROLL00030	30mm	12	18,00

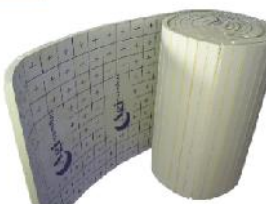

IT: Tubo Pex  
 EN: Pex Pipe  
 FR: Tube Pex

**Art TUBO P**

Codice	Misura	Box	€
TUBOP0000017	17 X 2	100	
TUBOP0000017	17 X 2	600	



Prezzi Netti a richiesta  
 Net prices on demand

IT: Tubo Multistrato Pex-Al-Pex  
 EN: Multilayer pipe Pex-Al-Pex  
 FR: Tube multicouche Pex-Al-Pex

**Art TUBO M**

Codice	Misura	Box	€
TUBOM0000016	16 X 2	500	
TUBOM0000020	20 X 2	100	



Prezzi Netti a richiesta  
 Net prices on demand

IT: Curva di sostegno  
 EN: Plastic elbow support  
 FR: Coude de soutien

**Art REGGICURVA**

Codice	Misura	Box	€
REGGICURVA16	16-18	50	2,35
REGGICURVA20	20-22	10	2,70



IT: Clips di fissaggio Tubo  
 EN: Fixing clips  
 FR: Clips de fissage

**Art CLIPS**

Codice	Misura	Box	€
CLIPS0001620	16.17.20	1000	0,15



IT: Giunto di dilatazione termica  
EN: Expansion Joint  
FR: Joint de dilatation

**Art GIUNTO**

Codice	Misura	Box	€
GIUNTO002000	2000 mm	1	3,50



IT: Rete Metallica Antiritiro 50x50 mm  
EN: Metallic net anti-shrinkage 50x50 mm  
FR: Filette métallique contre rétrécissement 50x50 mm

**Art RETE**

Codice	Misura	Box	€
RETE00000000	1X2	40	4,90



IT: Benda Perimetrale  
EN: Perimeter tape  
FR: Bande de polyethylene

**Art BENDA**

Codice	Misura	Box	€
BENDAPER0015	150 mm	1	2,15



IT: Additivo per Massetto  
EN: Additive for concrete  
FR: Additive

**Art FLUID**

Codice	Misura	Box	€
FLUIDMASD10	20 Lt	20L	4,95



€ al litro

IT: Graffettatrice per cplis  
EN: Stapler for clips  
FR: Agrafeuse pour clips

**Art GRAF**

Codice	Misura	Box	€
GRAF00000000		1	583,88



IT: Srotolatore  
EN: Unroller  
FR: Dérouleur

**Art SROTO**

Codice	Misura	Box	€
SROTO00000000		1	460,85



IT: Collettore in ottone da barra premontato con flussometro e valvole termostattizzabili

EN: Pre assembled Brass manifolds with flow meter and thermostatic valves

FR: Collecteur laiton pre-assemblé avec debimètres et robinets thermostattizables

**Art CPS 854**

Codice	Misura	Box	€
CPS8540100703	1"	1	186,00
CPS8540100704	1"	1	220,00
CPS8540100705	1"	1	255,00
CPS8540100706	1"	1	290,00
CPS8540100707	1"	1	325,00
CPS8540100708	1"	1	360,00
CPS8540100709	1"	1	395,00
CPS8540100710	1"	1	430,00
CPS8540100711	1"	1	463,00
CPS8540100712	1"	1	500,00
CPS8540100713	1"	1	528,00

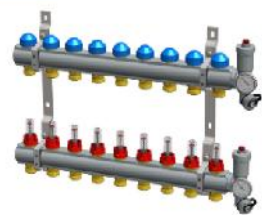

IT: Collettore in Acciaio INOX premontato con flussometro e valvole termostattizzabili

EN: Pre assembled Stainless Steel manifolds with flow meter and thermostatic valves

FR: Collecteur INOX pre-assemblé avec debimètres et robinets thermostattizables

**Art CPS 855**

Codice	Misura	Box	€
CPS8550100703	1"	1	154,00
CPS8550100704	1"	1	184,00
CPS8550100705	1"	1	222,00
CPS8550100706	1"	1	268,00
CPS8550100707	1"	1	301,00
CPS8550100708	1"	1	339,00
CPS8550100709	1"	1	376,00
CPS8550100710	1"	1	408,00
CPS8550100711	1"	1	443,00
CPS8550100712	1"	1	487,00



IT: Adattatore Eurocono per Tubo PEX

EN: PEX pipe adapter Eurokonus

FR: Adaptateur pour tube PEX Eurokonus

**Art DC 83P**

Codice	Misura	Box	€
DC0083P00716	3/4" X 16	10	3,27
DC0083P00720	3/4" X 20	10	3,27



IT: Adattatore Eurocono per Tubo Multistrato

EN: Multilayer pipe adapter Eurokonus

FR: Adaptateur pour tube multicouche Eurokonus

**Art DC 83M**

Codice	Misura	Box	€
DC0083M00716	3/4" X 16	10	3,22
DC0083M00720	3/4" X 20	10	3,22



IT: Testa Termostatica per Collettori 855 Quattro Fili

EN: Thermostatic head for manifolds 855 four connection

FR: Tête thermostatique pour collecteur 855 quatre fils

**Art CLI 508**

Codice	Misura	Box	€
CLI508000230	230v	1	39,90
CLI508000240	24v	1	39,90



IT: Testa Termostatica per Collettori 854 Quattro Fili

EN: Thermostatic head for manifolds 854 four connection

FR: Tête thermostatique pour collecteur 854 quatre fils

**Art CLI 507**

Codice	Misura	Box	€
CLI507000230	230v	1	42,00
CLI507000240	24v	1	42,00



IT: Gruppo di regolazione a punto fisso  
 EN: Fixed point mixing unit  
 FR: Régulateur de température à point fixe

**Art CPS 650**

Codice	Misura	Box	€
CPS65000010	1"	1	550,40



IT: By-Pass Primario con stacco Alta temperatura  
 EN: By-Pass Primary net with High temperature outlets  
 FR: By-Pass Circuit Primaire avec sortie Haute température

**Art CPS 651**

Codice	Misura	Box	€
CP651000010	1"	1	44,50



IT: Flussimetro 0-5 l/min  
 EN: Flow regulator 0-5 l/min  
 FR: Débitmètre 0-5 l/min

**Art CPS 654**

Codice	Misura	Box	€
CPS654000070	3/4"	1	20,80



IT: Vitone termostattizzabile  
 EN: Thermostatic valve for manifolds  
 FR: Vanne thermostatique pour collecteurs

**Art CPS 655**

Codice	Misura	Box	€
CPS654000070	3/4"	1	14,00





# Assotherm

Servizi associati per la termoidraulica

Sede Legale: Via F.lli Calvi,7 - 24060 Casazza (BG)  
Bergamo - ITALIA  
Tel +39 0 35813182 - Fax +39 0 35816892  
E-mail: [info@assotherm.com](mailto:info@assotherm.com) - Web: [www.assotherm.com](http://www.assotherm.com)